

D I G I T A L C O M B A T S I M U L A T O R

F-5E

TIGER II

for DCSWorld



Flight manual



THE FIGHTER COLLECTION

Eagle Dynamics

DCS
SERIES



TABLE OF CONTENTS

	INTRODUCTION.....	8
1	ABOUT THE F-5E	10
1.1	F-5 HISTORY	10
1.2	MAIN F-5 VERSIONS: FROM PROTOTYPES TO FINAL VERSIONS	30
1.3	F-5 EXPORT	35
2	GENERAL DESCRIPTION	38
2.1	F-5E-3 SPECIFICATIONS	40
3	AIRCRAFT DESIGN	43
	General	43
	Fuselage	45
	Cockpit.....	45
	Wing.....	46
	Speed Brake System.....	48
	Empennage (Tail).....	50
	Landing gear	50
4	COCKPIT	53
4.1	AIRCRAFT CONTROLS.....	54
	Control stick	55
	Throttle.....	55
	Rudder pedals.....	56
4.2	INSTRUMENT PANEL.....	57
4.3	INSTRUMENT PANEL INDICATORS AND INSTRUMENTS	58
	Flap Position Indicator	58
	AVU-8 Airspeed/Mach Indicator	58
	ARU-20/A Attitude Indicator	59
	Pitch Trim Indicator	60
	Angle-Of-Attack Indexer	60
	Clock.....	61
	Hydraulic Pressure Indicators	61
	Engine Tachometers (L&R)	61
	Aux Intake Doors Indicator	62
	Oil Pressure Indicator (Dual)	62
	Cockpit Pressure Altimeter	63
	Exhaust Gas Temperature Indicators (L&R)	63
	Fuel Quantity Indicator (dual)	64
	Nozzle Position Indicators (L&R).....	64

	Fuel flow indicator (dual)	65
	Master Caution Light	65
	Accelerometer	65
	Horizontal Situation Indicator	66
	AAU-34/A Altimeter	67
	Standby Attitude Indicator	67
	Angle-Of-Attack Indicator	68
	Vertical Velocity Indicator	69
4.4	LEFT VERTICAL PANEL	70
4.5	RIGHT VERTICAL PANEL	71
4.6	LEFT CONSOLE PANEL	72
4.7	RIGHT CONSOLE PANEL	73
4.8	PEDESTAL PANEL	74
5	J85-GE-21 ENGINE	76
	Compressor (1)	76
	Turbine (7)	77
	Variable Exhaust Nozzle (5)	77
	Accessory Gearbox (10)	77
5.1	AUXILIARY INTAKE DOORS	77
5.2	IGNITION SYSTEM	78
5.3	ENGINE CONTROLS / INDICATORS	79
5.4	ENGINE FUEL CONTROL SYSTEM	80
	Main Fuel Pump	80
	Main Fuel Control	80
	Overspeed Governor	80
	Variable Exhaust Nozzle Operation	80
	T5 Amplifier System	81
	Engine Inlet Temperature (T2)	81
	Afterburner System	82
5.5	ENGINE OPERATION	82
	Ground start	82
	Crossbleed start	82
	Airstart	83
	Engine windmill RPM	83
5.6	COMPRESSOR STALL	84
6	AIRCRAFT SYSTEMS	87
6.1	FUEL SYSTEM	87
	Fuel Boost Pump	87
	Fuel Float Switch	88
6.2	FUEL QUANTITY DATA	88
6.3	COCKPIT CONTROLS AND INDICATORS	89
6.4	FUEL SYSTEM MANAGEMENT	91

Autobalance Operation	91
Manual Balancing	92
Low Fuel Operation	93
Single Engine Operation.....	93
External Fuel Sequencing.....	93
6.5 ELECTRICAL SYSTEM	94
AC Power System	94
DC Power System.....	95
Static Inverter.....	95
6.6 HYDRAULIC SYSTEMS	95
Hydraulic Caution Lights	96
6.7 LANDING GEAR SYSTEM	96
Cockpit Controls and Indicators	97
Nose Gear Strut Hike-Dehike System	98
Landing Gear Alternate Extension	99
Landing Gear Downlock Override.....	100
Nosewheel Steering System	100
Wheel Brake System.....	101
6.8 ARRESTING HOOK SYSTEM.....	101
6.9 DRAG CHUTE SYSTEM	102
6.10 FLIGHT CONTROL SYSTEM.....	103
Controls and Indicators.....	104
Stability Augmenter System (Damping System).....	105
Rudder Travel	106
Horizontal Tail Travel.....	106
Pitot-Static System	106
6.11 WING FLAP SYSTEM	107
Flap Controls	107
FXD Flaps.....	108
AUTO Flaps	109
6.12 ANGLE-OF-ATTACK SYSTEM	111
AOA Indicator	111
AOA Indexer	112
Angle-of-Attack Displays Operation	112
AOA Switching Unit	113
6.13 WARNING, CAUTION, AND INDICATOR LIGHTS SYSTEM.....	113
Caution Light Panel	114
6.14 JETTISON SYSTEM.....	115
Select Jettison Switch at All Pylons.....	117
Select Jettison Switch at Select Position	117
6.15 LIGHT EQUIPMENT, EXTERIOR LIGHTS	117
Landing-Taxi Lights	119
Position and Fuselage Lights	120
Formation Lights	120

Rotating Beacon.....	121
6.16 INTERIOR LIGHTS	121
Flight and Engine Instrument Lights.....	121
Armament Panel Lights.....	121
Console Lights	121
Additional (Emergency) Interior Lighting	123
Lighting equipment controls	125
6.17 OXYGEN SYSTEM	126
6.18 ENVIRONMENTAL CONTROL SYSTEM	127
6.19 COMMUNICATION EQUIPMENT.....	130
Antenna Locations.....	130
Communications Controls Arrangement in Cockpit.....	131
6.20 TACAN AN/ARC(N)-118 NAVIGATION SYSTEM.....	133
TACAN AN/ARC(N)-118 Controls Arrangement in Cockpit	134
7 WEAPON SYSTEMS.....	137
7.1 WEAPON RELEASE SYSTEM	137
Weapon release controls.....	138
Reference Lines	140
7.2 JETTISON SYSTEM CONTROLS	140
7.3 WEAPON SUSPENSION SYSTEM.....	140
7.4 KB-26A SIGHT CAMERA	142
7.5 FIRE CONTROL SYSTEM	143
7.6 AN/APQ-159(V)-3 RADAR	144
AN/APQ-159(V)-3 Radar Controls.....	145
Range Gird	148
7.7 AN/ASG-31 LEAD COMPUTING OPTICAL SIGHT SYSTEM	148
AN/ASG-31 Controls	151
Reticle.....	152
7.8 AN/APQ-159(V)-3 SYSTEM OPERATION MODES	153
MISSILE(MSL) MODE.....	154
DOGFIGHT MISSILE (DM) Mode	158
DOGFIGHT GUN (DG) Mode	161
A/A1 GUNS Mode	164
ATTACK IN DG AND A/A1 MODE (NONTRACKING SOLUTION "SNAPSHOT")	164
A/A2 GUNS Mode (TRACKING SOLUTION).....	166
7.9 AN/ASG-31 SYSTEM OPERATION MODES.....	168
MISSILE(MSL) MODE.....	169
A/A1 GUNS and A/A2 GUNS MODES.....	169
MAN MODE.....	170
7.10 MISSILES	171
7.11 BOMBS.....	172
Mk-82	172

Mk-83	172
Mk-84	173
Mk-82 Snakeye	173
M117	174
CBU-52B	174
7.12 GUIDED BOMB	175
7.13 ROCKETS	175
7.14 FLARES.....	176
7.15 GUNS	177
7.16 MXU-648 CARGO POD	177
7.17 DEFENSIVE SYSTEMS.....	177
AN/ALE-40 Countermeasures Dispensing System	178
AN/ALR-87 Radar Warning System	179
Operating Unit Key Functions (Operation modes)	183
Audio Warning Tones	184
8 NORMAL PROCEDURES.....	186
8.1 ENGINE START	186
Before Start.....	187
Engine Start Sequence.....	187
Left Engine Start	188
Right Engine Start	190
Crossbleed Start.....	190
8.2 BEFORE TAXIING OUT	192
8.3 TAXIING.....	194
8.4 BEFORE TAKEOFF	195
8.5 TAKEOFF	197
8.6 CLIMB	198
Autobalance	198
Manual Balancing	199
8.7 LANDING	199
Before Landing	200
Landing approach and landing.....	200
After landing.....	202
Engine shutdown	202
9 AIRCRAFT AERODYNAMIC PARTICULARS.....	205
9.1 MANEUVERABILITY	205
9.2 CONTROL EFFECTIVENESS	205
Pitch	205
Roll/Yaw.....	206
Roll entry G	206
High pitch attitude/low airspeed flight.....	207
9.3 STALLS/SPINS	207

Stalls.....	208
Stall recovery.....	208
PSG	208
Spins	209
10 COMBAT EMPLOYMENT	211
10.1 AIR-TO-AIR COMBAT EMPLOYMENT	211
JOINT OPERATION OF RADAR AND SIGHT SYSTEM DURING	
AIR-TO-AIR COMBAT.....	211
Dogfight Missile(DM)Mode	215
Dogfight Gun(DG) Mode	220
GUN A/A1 and A/A2 GUNS MODES	224
A/A1 GUNS MODE	224
A/A2 GUNS mode.....	225
OPTICAL SIGHT OPERATION DURING AIR-TO-AIR COMBAT	229
AIM-9P Missile Employment.....	229
SCOPE SIGHT OPERATION DURING AIR-TO-AIR COMBAT	
WITH M-39A3 GUNS.....	231
A/A1GUNS Mode Employment	231
A/A2GUNS mode employment	233
10.2 AIR-TO-GROUND COMBAT EMPLOYMENT	235
MK-82,83,84 and M117 Bomb Dropping	235
Rocket Attack	239
Gun Attack	241
Flare Drop	244
Laser-guided bomb delivery using a JTAC.....	245
11 FLIGHT AND OPERATIONAL LIMITATIONS.....	253
Engine performance indicators and limitations	253
Overspeed or Overtemperature	254
Fuel system limitations	254
Flight Limitations.....	255
Prohibited maneuvers.....	256
12 EMERGENCY PROCEDURES	258
CADC / Pitot-Static System Malfunction	258
Flaps AUTO mode failure	259
Engine fire.....	259
Single-Engine Takeoff.....	260
In-Flight Engine Failure.....	260
Single-Engine flight	261
Airstart.....	261
Single-Engine Approach and Landing	264
No-Flap Approach and Landing.....	265

	Landing Gear Retraction Failure after Takeoff/Missed approach	265
	Landing Gear Alternate Extension	265
	Engine stall	266
	Cockpit smoke	266
	Nozzle Failure	266
	Loss of canopy	267
	Electrical system failure	267
	Hydraulic Systems Failure	268
	Airframe Gearbox Failure	268
13	SUPPLEMENTS	271
	Engine Fuel Control System	271
	Fuel System	272
	Electrical System	273
	Hydraulic Systems	274
	Environmental Control System	275
14	KEY COMMANDS	277
15	DEVELOPERS	286
	Management	286
	Programmers	286
	Designers	286
	Video	286
	Training	286
	Quality Assurance	286
	Science Support	286
	Localization	287
	Special Thanks	287
	Tester Staff	287

INTRODUCTION

The DCS: F-5E Tiger II module is a simulation of the F-5E fighter, the aircraft that was in military service almost in 30 countries worldwide in the second half of the 20th century.

This simulator allows you to enjoy the flight and carry out combat missions on one of the most advanced versions of the light tactical fighter, the F-5E. The main distinctive features of this version are improved nose section of the shark nose type, increased wing surface area of the leading edge extensions, and capability to control flap position automatically. Air-to-air missiles and two 20-mm guns combined with excellent aircraft maneuverability and controllability allow us to reveal its full potential.

A wide range of armament carried on five hard-points makes this aircraft the nightmare for enemy land forces.

Each famous aircraft has its own unique history. Section HISTORY briefly describes the creation of light fighter concept, as well as its development and becoming the international combat aircraft.

This DCS: F-5E Tiger II Manual comprises a full description of the aircraft, operation of all aircraft systems and weapons, main procedures from engine start-up to its shutdown after landing, and all variants of combat application of this tactical fighter. We highly recommend you to study Section EMERGENCY PROCEDURES. Even if a failure is not input from the Mission Editor, different emergencies may happen after exceeding some limitations or due to combat damages. For example, the landing gear may fail to extend, the pressure may drop in hydraulic system, or one engine may fail in flight.

We hope you will like DCS: F-5E Tiger II module and get excited about all its features while reading this manual.



1 ABOUT THE F-5E

1 ABOUT THE F-5E

1.1 F-5 History

At the beginning of 1950s, military jet aviation development was defined by pursuit of flight speed and altitude. However, achieving of the necessary characteristics came with increased aircraft weight and degradation of maneuvering, takeoff and landing performance. American fighters became heavier in less than a decade, that's why they needed more powerful engines.

In the late 1950s, the Air Force required supersonic fighters capable of carrying out ground attacks with conventional (non-nuclear) weapons. The key goal was to combine high combat performance with easy mastering, low cost and versatility. It became clear that a mass-produced fighter had to be cheap, simple and low-maintenance aircraft.

In 1953 the American Northrop Corporation started designing of a light fighter with a delta wing and bottom-mounted intake. Edgar Schmued, the designer of the famous P-51 Mustang and F-86 Sabre, who had been working at Northrop Corporation since 1950, participated in new fighter concept development.



Figure 1.1 Edgar Schmued – American aircraft designer of German origin

This project was designated as N-102 Fang. Apart from being able to perform ground attacks the future fighter was planned to be optimized to tactically engage such adversaries as the Mig-15, 17, 19 etc.



Figure 1.2 N-102 Fang Light fighter mockup – considered to be the F-5 predecessor

However, in 1955 the project was canceled for a number of reasons. The N-102 was abandoned as a viable option but Northrop Corporation designers continued to work on the light fighter concept as a private initiative alongside other projects.

Having analyzed production and maintenance costs of the century series aircraft (F-100, F-102, F-104 etc.) which were in service at those times, Northrop specialists concluded that light, simple and high performance aircraft could be a real competitor in the fighter market.

After careful study the company proceeded to development of the light fighter designated as N-156.

The development of the N-156 started in 1955. Engine location, tail configuration and crew capacity was changed multiple times. Another consideration was the installation of rocket engines.



Figure 1.3 N-156F full-scale mockup in hangar, March 1957

The aircraft service life of at least 10 years was one of the most important requirements. By the end of the year, the single-seat N-156F fighter and its two-seat training variation (N-156T) were considered to be most advanced versions.



Figure 1.4 Palmdale facility, assembly shop

At the same time the company offered this light twin-engine supersonic aircraft to the US allies as a part of MAP (Military Assistance Program).

In November 1955 the US Air Force announced a tender to develop two-seat supersonic training aircraft intended to replace the subsonic T-33s. The N-156T won and in June 1956 the Air Force ordered three prototypes from Northrop Corporation.



Figure 1.5 The first three YF-38s often flew with closed rear compartment in which different equipment resided

After some additional work T-38 Talon was designed. The flight of the first supersonic training aircraft took place in 10 April 1959. In May 1960 the first production aircraft (T-38A) made its test flight. The first T-38As entered service of Air Training Command of United States Air Force on 17 March 1961.



Figure 1.6 Pair of T-38As Talon from 560th training squadron, Randolph air base



Figure 1.7 T-38A at Holloman airbase, New Mexico

Training aircraft were produced in two versions: T-38A – for initial training and T-38V — for advanced training.



Figure 1.8 Practice bomb container fixed under the camouflaged T-38V

Statistics show that there are 2.2 aircraft accidents per 100 thousand flight hours. But, the T-38 was so reliable that not only American pilots use them for training (their number has surpassed 40 thousand), but NASA astronauts as well. Pilots from Portugal, Taiwan, Turkey and other countries were also trained with help of these aircraft.



Figure 1.9 Endeavour space shuttle crew (STS-134 mission) arrived in T-38's at Kennedy space center, cape Canaveral, Florida, 26 April 2011

In the meantime, Northrop did not stop work on N-156F. They adhered to the initial concept in development of light fighter aircraft. They believed in this project and they were right. The Pentagon signed a contract with Northrop Corporation for the development of a relatively simple and cheap supersonic fighter, capable of ground strikes and dogfight. The fighter was primarily designed for export as part of different Mutual Aid Programs (MAP) to replace outdated Thunderjet and Sabre aircraft.



Figure 1.10 N-156F at Edwards airbase together with the two first YF-5As

Three months after the maiden flight of the T-38 Talon, on the 30th of July 1959 the first F-5 fighter prototype made its maiden flight at the US Air Force Edwards test center. Test pilot Lew Nelson broke the sound barrier during his first flight.



Figure 1.11 N-156F in flight

After the first test stage was finished in August 1960, three pre-production YF-5A (trademark NF-5A) were tested according to the comprehensive combat test program as multirole fighter, their operability in different climate conditions, from tropics to the Arctic regions, at day and night time, was assessed. It is worth noting that the YF-5A was the first among American

supersonic jet fighters which performed takeoff and landing using unprepared runway.



Figure 1.12 Northrop YF-5A (S/N 63-8372) landing on unprepared field. (U.S. Air Force photo) with two 500 lbs bombs and fuel tanks on wingtips

N-156F project progress was justified by the T-38 Talon being the sole NATO training aircraft at a relatively low price.



Figure 1.13 N-156F prototype with 250lb bombs fixed on three pylons

In April 1962, the Pentagon officially announced the F-5 as a prime aircraft to be exported under the MAP program. In August that year the contract for serial production of 170 single-seat F-5As and training twin-seat F-5Bs was signed.



Figure 1.14 F-5A fighter and F-5B training aircraft in formation

In February 1964, the company got its first export order for 64 aircraft from Norway. The customer demanded to improve the initial F-5A version in order to ensure optimum operation in the Arctic conditions. The Norwegian F-5A(G)s were equipped with a windshield defog system and arresting hook for landing on short runways of high-level airfields. Then there were orders from Iran, Greece, South Korea and by the end of 1965 the backlog of orders was at near 1000 fighters. The F-5A was really becoming an "international" fighter.



Figure 1.15 F-5A firing rockets at ground target

In February 1964, the twin-seat F-5B fighter made its maiden flight. As opposed to T-38 Talon trainer, F-5B's had air intakes with wider cross section and underwing pylons. F-5B's nose was formed in the way that creates more lift. The capability of carrying weapons externally made the F-5B fully valid training aircraft.



Figure 1.16 One of the first supersonic training aircraft F-5B, flight preparation



Figure 1.17 Takeoff of F-5B

In parallel with the start of F-5A/B production, the RF-5A specialized reconnaissance version was being developed. The new aircraft got specially designed elongated nose with four 70 mm KS-92 cameras. The bay configuration allowed films replacing in 5 minutes. At the same time, standard

cannon armament was preserved. Deliveries of serially produced RF-5A started in 1965. The total number of the produced aircraft is 89.



Figure 1.18 Norwegian Air Force RF-5A

Northrop managers initially counted not only on the aircraft export but also on their licensed production.

In the 60s Canada needed to replace obsolete CL-13 Sabre and not very effective Starfighters (Canadair CL-90). The Phantom was the most probable candidate. However, it was considered to be too expensive but F-5 was almost perfect in terms of price and effectiveness. Contract for licensed production of the F-5 was signed in 1965.



Figure 1.19 CF-5A fighter with external tanks

The Canadian CF-5A fighter (CF-5D is a two-seat version) differed from the initial version with the more powerful Orenda J85 engines. These engines had

more thrust than other similar American engines: Orenda J85-CAN-15 had 4300 lb static thrust (1950 kgf), and thrust of the American J85-GE-13s powering most of the F-5As and Bs was 4080 lb (1673 kgf). Increased thrust had positive impact on Canadian aircraft combat characteristics, flight and climb speed.



Figure 1.20 Canadian Air Force CF-5A fighter during rocket launch

Canadian CF-5A design was modified in the course of its production based on experience gained in combat evaluation of American aircraft in Vietnam as part of Skoshi Tiger program. Particularly, the CF-5A was fitted with aerial refueling system with it being on the other side, not as in American aircraft (upgraded for Vietnam F-5C). Necessary runway length was reduced by 25 % due to a new adjustable nose gear strut. Additional armoring was also implemented, canopy design and underwing pylons were changed. Navigation and radio systems were changed as well. Arresting hook was installed (most of Canadian airfields had arrestor systems).



Figure 1.21 Modified Canadian CF-5A and delivered to Venezuela as VF-5A

Different versions of F-5 aircraft were built under license in Spain, Malaysia, Switzerland, Korea and Taiwan.



Figure 1.22 F-5 being assembled at Swiss Federal Aircraft Factory, Emmen

Almost all versions of F-5 aircraft produced by US or foreign factories under license were constantly modified. All these modifications were carefully analyzed by Northrop specialists.

This analysis significantly aided the progress of N-156 project. In 1970, Northrop Corporation once again won the IFA (International Fighter Aircraft)

competition to produce a simple and inexpensive international fighter. By the way, the reason for this competition was appearance of new versions of the Soviet MiG-21, which dominated over the F-5A. Development of a new and more powerful General Electric J85-GE-21 engine intended for use in light tactical fighters gave birth for a new version of the aircraft, the F-5E.

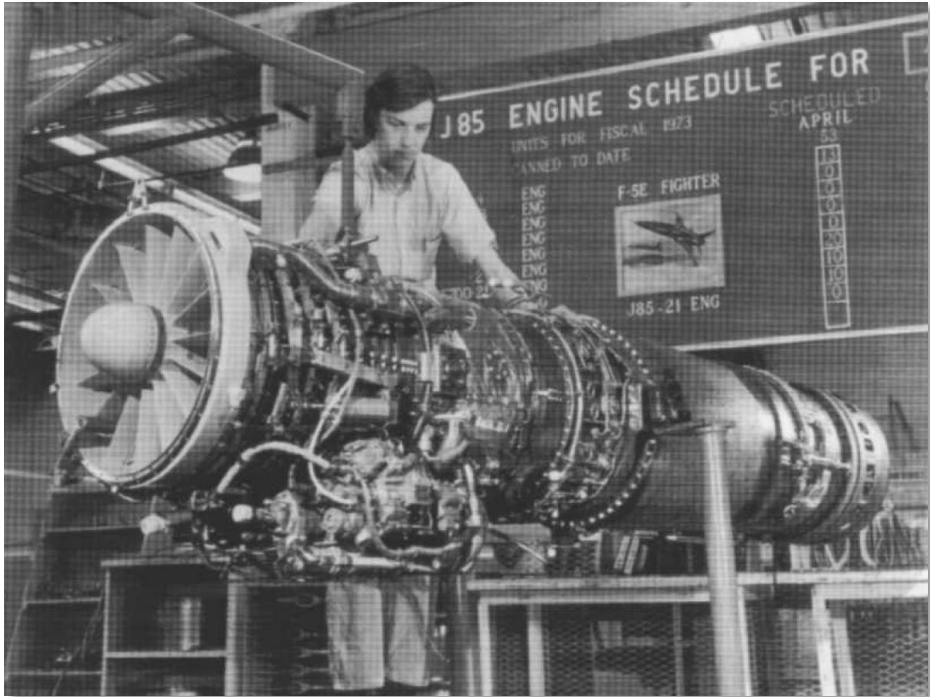

Figure 1.23 J85-GE-21 engine for F-5E fighter in production shop

Next step in F-5 fighter modernization program became the F-5A-21, also known as F-5E Tiger II.



Figure 1.24 Official roll-out of F-5E

As a result of wars in Vietnam and Middle East, the role of light tactical fighters was reconsidered. These changes were implemented both on production lines and R&D at the same time. Many engineering solutions used in F-5A/B versions were put together and implemented in a new basic modification aimed at dogfights under visual flight conditions.

The first serial production F-5E flew at Edwards Air Force Base on 11 August 1972. Its two-seat version, the F-5F, was demonstrated two years later, making its first flight on 25 September 1974.



Figure 1.25 Early F-5E in flight

The F-5E was powered by a more powerful General Electric J85-GE-21 engine having a 5,329 lbf (2,185 kgf) afterburner thrust. This type had many significant improvements, such as:

- auto flap system providing automatic flap operation depending on flight conditions, similar to the systems used in Netherlands NF-5A/B;
- increased wing area owing to changes in wing span and shape of the wing leading edge extensions;
- arresting hook that proved its reliability in Canadian, Norwegian and Dutch versions;
- Emerson Electric AN/APQ-153 pulse radar;
- capability to carry the AGM-65 Maverick air-to-ground tactical missiles and Mk. 84 LGB laser-guided bombs;
- extensively changed air navigation equipment and weapon control systems;
- increase in fuel quantity by 300 liters due to the longer and wider fuselage;
- An increase in the diameter of the engine intake as part of a defined requirement to increase the allowable volume of air inside the engine;
- increased wheel base and track and a new two-position extendable nosewheel strut.



Figure 1.26 F-5E at Mexico Air Force Base, armament demonstration

The F-5E aircraft and its versions (F-5F combat-capable trainer and RF-5E reconnaissance aircraft) became one of the most popular tactical fighters in the world.



Figure 1.27 F-5F with external tanks, Maverick and Sidewinder missiles. The red box under the nose is a camera for armament usage recording

The key reason why this aircraft was so popular was individual and flexible customer approach by the designers. Therefore, sometimes aircraft delivered in different countries differed dramatically in their equipment.



Figure 1.28 Two Brazilian Air Force F-5E with aerial refueling hoses



Figure 1.29 Swiss Air Force F-5E in flight

The F-5 aircraft family was in service in 30 countries worldwide. In some countries this aircraft operated as a main combat unit. In 2014, approximately

five hundred different versions of F-5 were still in service. And after upgrading the avionics and armament, many of them will remain in service for the foreseeable future.



Figure 1.30 Aggressor squadron F-5N fighters in Nevada's sky

The United States "Tigers" served in aggressor squadrons with Air Force, Navy and Marines. The best pilots were selected for aggressor squadrons and it is not surprising that most of the time F-5s won in combat trainings against more advanced F-14s, F-15s and F-16s.

1.2 Main F-5 Versions: from prototypes to final versions

Table 1.1 F-5 Versions

Company designation (project name)	Military designation	Engine	Flight testing initiation	Introduction	Description
N-156		2xJ85	-	-	Multirole light fighter, 1995. Aft-tail aircraft with tapered low wing.
N-156T		2xJ85	-	-	Trainer, 1955. Prototype for T-38 Talon.
N-156F		2x J85-GE-5 or J85-GE-13	1959	-	Prototype, 2 aircraft in 1958-59, Northrop Hawthorn (California). Fitted with 1,215/1,750 kgf (11.93/17.13 kH) turbojet engines with afterburner, two 20-mm M39A2 cannons with 280 rounds per gun, and seven hard points.
	XF-5A	2xJ85-GE-13A		-	Prototype, 1 aircraft used for static tests.
N-156F	YF-5A	2xJ85-GE-13A	1963		Pre-production prototype, 2 aircraft in 1962-63, Northrop Hawthorn (California).
N-156A	F-5A Freedom Fighter	2xJ85-GE-13A or J85-GE-13D	1963	1963	USAF. Produced by Northrop Hawthorn (California) in 1962-72, 621 aircraft were built (18 to USAF, others were exported).
N-156B	F-5B (F-5-21)	2xJ85-GE-13	1964		Two-seat version. Produced by Northrop Hawthorn (California) in 1963-75, 180 aircraft were built (23 to USAF, others were exported) + 4 aircraft upgraded from F-5A.
	GF-5B	2xJ85-GE-13			Ground based trainer, 5 aircraft (converted from F-5B).
N-156C	RF-5A	2xJ85-GE-13		1965	Reconnaissance aircraft with elongated nose section, 4 KS-92 aerial reconnaissance cameras. Produced by Northrop Hawthorn (California), 89 aircraft were built.

Company designation (project name)	Military designation	Engine	Flight testing initiation	Introduction	Description
	F-5C Skoshi Tiger	2xJ85-GE-15	1965		Fitted with 1,327/1,950 kgf turbojet engines with afterburner, armored cockpit bottom and fuel cells section, and aerial refueling system. Twelve F-5As modified for tests in Vietnam.
	F-5A(G)	2xJ85-GE-15			Export version (Norway). Adapted for operation under cold conditions: improved cockpit and arresting hook. Seventy-five aircraft were built.
	RF-5A(G)	2xJ85-GE-15			Reconnaissance aircraft.
	F-5B(G)	2xJ85-GE-15			Export version (Norway). Adapted for operation in cold conditions. Twenty-two aircraft were built.
CL-219	CF-5A (c 1976 r. - CF-116A)	2xOrenda J85-Can-15	1959		Export version (Canada). Fitted with Canadian 1,950 kgf turbojet engines with afterburner and aerial refueling system. Produced under license in 1967-74 by Canadair, 89 aircraft were built.
	CF-5D (CF-116D)	2xOrenda J85-Can-15			Two-seat export version (Canada). Fitted with laser target designator. Produced under license in 1967-75, 48 aircraft were built.
	NF-5A	2xOrenda J85-Can-15	1969		Licensed Canadian CF-5A for Netherlands Air Force. Produced in 1968-72, 75 aircraft were built.
	NF-5B	2xOrenda J85-Can-15	1969		Licensed Canadian CF-5D for Netherlands Air Force. Produced in 1968-72, 30 aircraft were built.
	VF-5A	2xOrenda J85-Can-15			Licensed Canadian CF-5A for Venezuelan Air Force
	VF-5B	2xOrenda J85-Can-15			Licensed Canadian CF-5B for Venezuelan Air Force

DIGITAL COMBAT SIMULATOR F-5E

Company designation (project name)	Military designation	Engine	Flight testing initiation	Introduction	Description
	YF-5D	2xJ85-GE-21B		-	Prototype, 1 aircraft (modified F-5B, Prototype for F-5E).
	SF-5A (C-9)	2xJ85-GE-13			Export version (Spain). Produced under license by CASA Madrid, Seville, in 1967-71, 19 aircraft were built.
	SF-5B (CE-9)	2xJ85-GE-13			Export version (Spain). Seventeen aircraft were built under license.
	SRF-5A (SR-9)	2xJ85-GE-13			Export version (Spain). Thirty four aircraft were built under license.
	F-5D		-	-	USAF. was not built.
	YF-5B-21	2xJ85-GE-21B	1969	-	Prototype, 1 aircraft (modified F-5B). Fitted with 1,590/2,270 kgf (15.6/22.2 kN) turbojet engine with afterburner.
IFA (International Fighter Aircraft)	F-5E Tiger II (F-5A-21)	2xJ85-GE-21B	1974		Started in 1970. Scaled-up version of F-5a equipped with Emerson Electric AN/APQ-153 or AN/APQ-159 radar, AN/ARN-118 TACAN navigation system, AN/ASG-31 lead computing optical gun sight system, wing leading edge extensions, two 20-mm M39A2 cannons (280 rounds per gun), seven external store pylons. Produced by Northrop Hawthorn (California) in 1971-89, 1150 aircraft were built (49 to USAF, 31 to USN, others were exported).
	F-5F	2xJ85-GE-21B	1974		Two-seat version. Fitted with AN/APQ-157 radar (AN/APQ-153 derivative with dual control), one 20-mm M39A2 cannon with 140 rounds. Produced by Northrop Hawthorn (California) in 1974-86, 255 aircraft were built (12 to USAF, 4 to U.S. Navy, others were exported).

Company designation (project name)	Military designation	Engine	Flight testing initiation	Introduction	Description
	RF-5E Tiger Eye	2xJ85-GE-21B	1979	1982	Reconnaissance aircraft. Equipped with elongated nose section (AN/APQ-157 radar, 2 aerial reconnaissance cameras), one 20-mm M39A2 cannon, and aerial refueling system. Produced by Northrop Hawthorn (California) in 1982-83, 12 aircraft were built for export.
	RF-5E Tigergazer	2xJ85-GE-21B			Upgraded RF-5E (Taiwan).
	F-5E Tiger III	2xJ85-GE-21B			Upgraded F-5E (Chile Air Force).
	F-5S	2xJ85-GE-21B	1994		Upgraded version of Singapore Air Force F-5Es made by Singapore Technologies Aerospace (STAE), 26 aircraft were made. Fitted with FIAR Gryphon F radar, capable of firing AIM-120 AMRAAM missiles.
	RF-5S	2xJ85-GE-21B			Upgraded version of Singapore Air force F-5S made by Singapore Technologies Aerospace (STAE), 8 aircraft were made.
	F-5T	2xJ85-GE-21B	1994		Upgraded version of Singapore Air force F-5F made by Singapore Technologies Aerospace (STAE)
	F-5T	2xJ85-GE-21B			Upgraded version of Thai Air Force F-5E made by Israel.
	KF-5A	2xJ85-GE-21B			Licensed version of F-5E built by Republic of South Africa for Republic of Korea Air Force
	KF-5B	2xJ85-GE-21B			Licensed version of F-5F built by Republic of South Africa for Republic of Korea Air Force
N-300		2xGE15-J1A1			Project, 1965. Powered by 4083 kgf turbojet engine with afterburner.

DIGITAL COMBAT SIMULATOR F-5E

Company designation (project name)	Military designation	Engine	Flight testing initiation	Introduction	Description
	F-5N Adversary (F-5A-15)	2xJ85-GE-15			U.S. Navy. Fitted with radar (without built-in cannons), upgraded avionics, new nose gear strut, auxiliary intake doors, five external store pylons. Thirty five ex-Swiss F-5Es and 6 U.S. Navy F-5Es upgraded by Northrop-Grumman Corp. (Florida).
	F-5N	2xJ85-GE-15			Upgraded, 2008. Fitted with INS Northrop Grumman LN-260 (F-16 Fighting Falcon), GPS, and new display.
	F-5EM	2xJ85-GE-21B			Upgraded version of F-5 (EADS/CASA).
	F-5FM	2xJ85-GE-21B			Upgraded version of F-5 (EADS/CASA).
	F-5 Plus Tiger III	2xJ85-GE-21B			Upgraded version of F-5 (IAI).
	F-5E Tiger IV				Upgraded version of F-5 (Northrop-Grumman).
	F-5 Tiger 2000				Upgraded version of F-5 (Northrop-Grumman).
F-5BR	F-5EM	2xJ85-GE-21B			Upgrading program (Brazil) involving participation of Israel Elbit, 2001. Fitted with new radar with increased radome, 2 onboard computers, 3 color displays, helmet mounted display, night vision goggles, INS/GPS. Service life was extended by 15 years.
F-5BR	F-5FM	2xJ85-GE-21B			Two-seat version
	F-5F Franken-Tiger	2xJ85-GE-21B	2008		USMC, U.S. Navy. Development started in September 2005. Two-seat trainer. Three aircraft (made at plant in St. Augustine, Florida, from nose and aft sections taken from USN F-5E Tiger II and central section from ex-Swiss Air Force F-5F).

Company designation (project name)	Military designation	Engine	Flight testing initiation	Introduction	Description
	F-5X	1xGeneral Electric F404 or 2xGarret TFE-731	-	-	Project, 1975.
FX (Fighter Experimental)	F-5G (F-5G-1)	1xF404-GE-400	-	-	Export version of multirole fighter. Project, 1979. Fitted with Emerson APQ-159 radar, 7,300 kgf turbofan engine with afterburner, redesigned aft section, scaled-up air inlet duct, wing, and empennage similar to F-5E, and one cannon. Maximum Takeoff Weight is approx 12,000 kg and payload approx 4,300 kg.
FX (Fighter Experimental)	F-5G-2	1xF404-GE	-	-	Project, 1981. Fitted with AN/APG-69 radar
FX (Fighter Experimental)	F-20 Tigershark (F-5G)	2xF404-GE-100A	1982	-	Export version of multirole fighter. Fitted with AN/APG-67(V) radar, two 20-mm M39A2 cannons, AIM-7F, AIM-9 and AGM-65 missiles, Paveway laser-guided bombs, and 5000/8150 kgf turbofan engine. Three aircraft was produced in 1981-82.
Quiet Supersonic Platform program	F-5 Shaped Sonic Boom Demonstrator	2xJ85-GE-21B	2003		Testbed aircraft for sonic boom research. Converted from F-5C
N-156E		2xCF-700	-	-	Project
N-156NN			-	-	Project for T-Tail Naval fighter
N-156D (N-285B)			-	-	Project, further development of N-156NN

*<http://www.militaryparitet.com>

1.3 F-5 Export

All versions of the F-5 were exported in many countries across the world.

Table 1.2 Export history for all F-5 versions

Country / Region	Number of exported aircraft
Norway	78 F-5A(G), 14 F-5B, 16 RF-5A(G)

DIGITAL COMBAT SIMULATOR F-5E

Country / Region	Number of exported aircraft
Taiwan	101 F-5A, 12 F-5B in 1965, 226 F-5E (licensed), 74 F-5F (licensed)
Turkey	75 F-5A, 16 F-5B in 1965, 20 RF-5A;
Greece	42 F-5A, 8 F-5B in 1965, 16 RF-5A; 100-110 CL-13 Mk 2 in 1954, 50 F-86D in 1958.
Brazil	52 F-5E, 3 F-5F. Since 2001 till 2008 23 aircraft were upgraded under F-5BR Program (F-5EM/FM)
Jordan	F-5A, 5 F-5B, 61 F-5E, 12 F-5F
Libya	8 F-5A, 2 F-5B
Morocco	20 F-5A, 2 RF-5A, 26 F-5E, 4 F-5F
Switzerland	98 F-5E, 12 F-5F
Mexico	10 F-5E, 2 F-5F
Kenya	10 F-5E, 4 F-5F
Bahrein	8 F-5E, 4 F-5F
Botswana	15 F-15A/B
Chile	15 F-5E, 3 F-5E
Singapore	35 F-5E, 6 F-5F
South Vietnam	35 F-5A, 10 RF-5A, 6 F-5B, 58 F-5E
North Yemen	12 F-5E
Sudan	2 F-5E, 2 F-5F
Egypt	50 F-5E (order Saudi Arabia)
South Korea	87 (90, according to other sources) F-5A, 34 F-5B в 1965 г., 8 (10, according to other sources) RF-5A, 161 (170, according to other sources) F-5E, 40 F-5F;
Venezuela	Canadian CF-116;
Philippines	19 F-5A, 1 F-5B in 1965
Saudi Arabia	F-5A, 20 F-5B, 40 F-5E, 24 F-5F, 10 RF-5E
Iran	104 F-5A, 24 F-5B, 13 RF-5A, 171 F-5E, 28 F-5F
Ethiopia	13 F-5A, 2 F-5B, 8 F-5E r
Thailand	21 F-5A, 5 F-5B, 4 RF-5A, 35 F-5E, 6 F-5F
Tunisia	13 F-5E, 4 F-5F
Malaysia	F-5A, 2 F-5B, 17 F-5E, 4 F-5F, 2 RF-5E
Indonesia	ex-USAF 12 F-5E и 4 F-5F in 1982 (upgraded in Belgium in 1995)

Sources:

<http://www.militaryparitet.com>
<http://aviadejavu.ru>
<http://worldweapon.ru>
<http://www.airwar.ru>

<https://www.militaryperiscope.com>
<http://topgun.rin.ru>
www.aviationclassics.co.uk

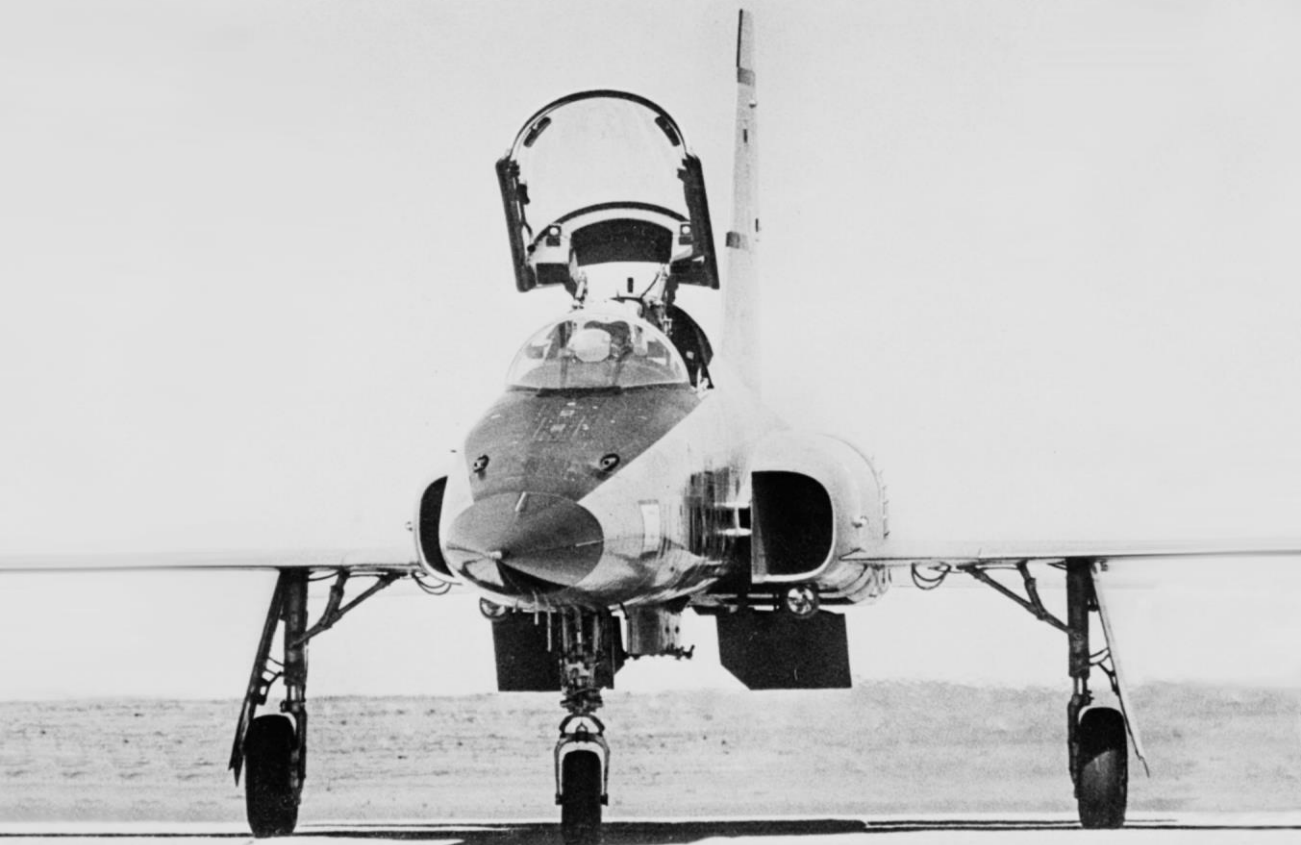

F-5E II

TIGER



2 GENERAL DESCRIPTION

2 GENERAL DESCRIPTION

The F-5E was developed by Northrop Corporation in early 1970s. The light tactical fighter is an upgraded version based on previous F-5A developments. The F-5s' combat role encompasses air superiority, ground support, and ground attack.

The Aircraft has trapeziform wings, two turbojet engines equipped with afterburners, and tricycle landing gear. Pitch, roll, and yaw control systems are hydraulically actuated in order to relieve control stick and rudder pedals forces. Artificial feel system is built in pitch and roll control systems to simulate aerodynamic loads for the pilot.

After the landing gear retraction, the left and right movement of the control stick is limited by a spring mechanism that prevents excessive roll rates.

Pressurized cockpit and air conditioning system ensure pilot's safety at all altitudes up to the service ceiling. The pilot is also provided with an oxygen mask and anti-g suit. The cockpit is fitted with an ejection seat SIII S-3 by "Martin Baker" company.

The aircraft is equipped with two UHF radios, automatic direction finder, radio navigation system and a standard set of navigation lights.

Landing-taxi lights located on the underside of each engine inlet duct are extended together with the landing gear.

The cockpit canopy provides a superb in-flight view appropriate for air-to-air operations.

The F-5E is armed with two 20-mm M39-A3 cannons with 280 rounds per each cannon. The cannons are located in the nose section forward of the cockpit. Special deflectors are used to avoid compressor stall conditions caused by hot gas ingestion as a bi-product of operating the M-39-A3.

Each cannon is capable of firing at a rate of 1500 to 1700 rounds per minute.

Each wingtip incorporates a launcher rail capable of firing the AIM-9 infrared-guided missiles.

Five hard points (one centerline pylon and four underwing pylons) allow the aircraft to carry different types of air-to-ground weapons (bombs, cluster munitions, rockets) 6,400 pounds (about 3000 kg) in total. In addition,

illumination ammunition and containers for cargo transportation can be attached.

To increase flight duration and range, external fuel tanks can be attached to three hard points (a centerline pylon and two inboard pylons).

Maneuverability and speed can be maximized in combat by jettisoning all external stores.

2.1 F-5E-3 Specifications

Table 2.1 F-5E Specifications

Crew	1	
Performance		
Empty weight	lb // kg	10,659 // 4,835
Maximum takeoff weight	lb // kg	24,663 // 11,180
Loaded weight (fuel and gun munitions)	lb // kg	15,556 // 7,057
Maximum payload	lb // kg	7,000 // 3,175
Internal fuel (JP-4, 0.778 kg/l)	lb // kg	4,511 // 2,046
External fuel	lb // kg	5,950 // 2,700
J85-GE-21 engine	2	
Dry thrust	lb // kgf	3,250 // 1,474
Thrust with afterburner	lb // kgf	4,650 // 2,109
Maximum airspeed near ground	kn // km/h	670 // 1,240
Maximum TAS at 36000 ft (maximum thrust)	kn // km/h	950 // 1,760 (M=1.63)
Maximum TAS at 36000 ft (military thrust)	kn // km/h	652 // 1,050 (M=0.98)
Service ceiling (at 14,000 lbs weight)	ft // m	54,000 // 16,460
Maximum rate of climb	ft/m // m/s	32,480 // 165
Range	nm // km	870 // 1,400
Range with external fuel tanks	nm // km	1,780 // 2,860
Dimensions*		
Length	ft // m	47.04 // 14.45
Width (wingspan) / with missiles	ft // m	26.7/28 // 8.13/8.53
Height over tail	ft // m	13.3 // 4.06
Wing sweep	degrees	32
Wing area	m ²	17.3
Wheel track	ft // m	12.5 // 3.8
Wheel base	ft // m	16.9 // 5.15
Armament		
two 20-mm M39-A3 cannons	rounds	2 X 280
AIM-9 Sidewinder missile	qty	2
Various bombs, cluster munitions, rockets		

* Aircraft dimensions are shown on the figure

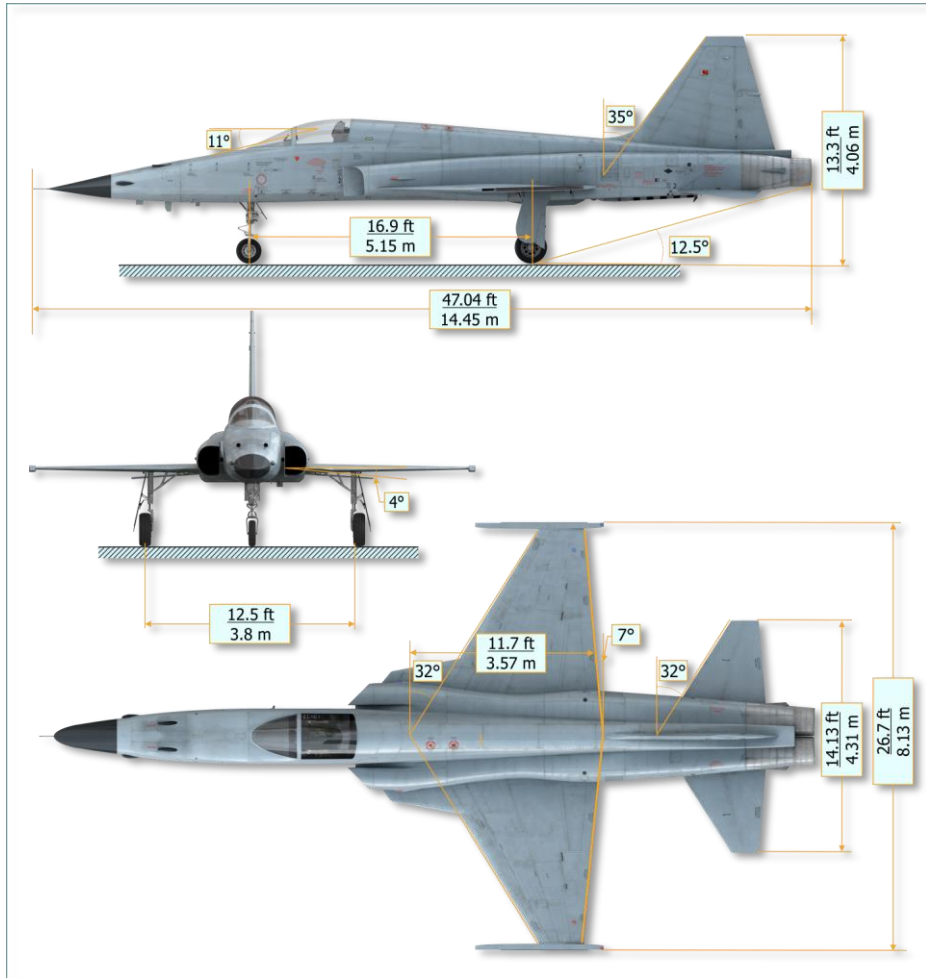
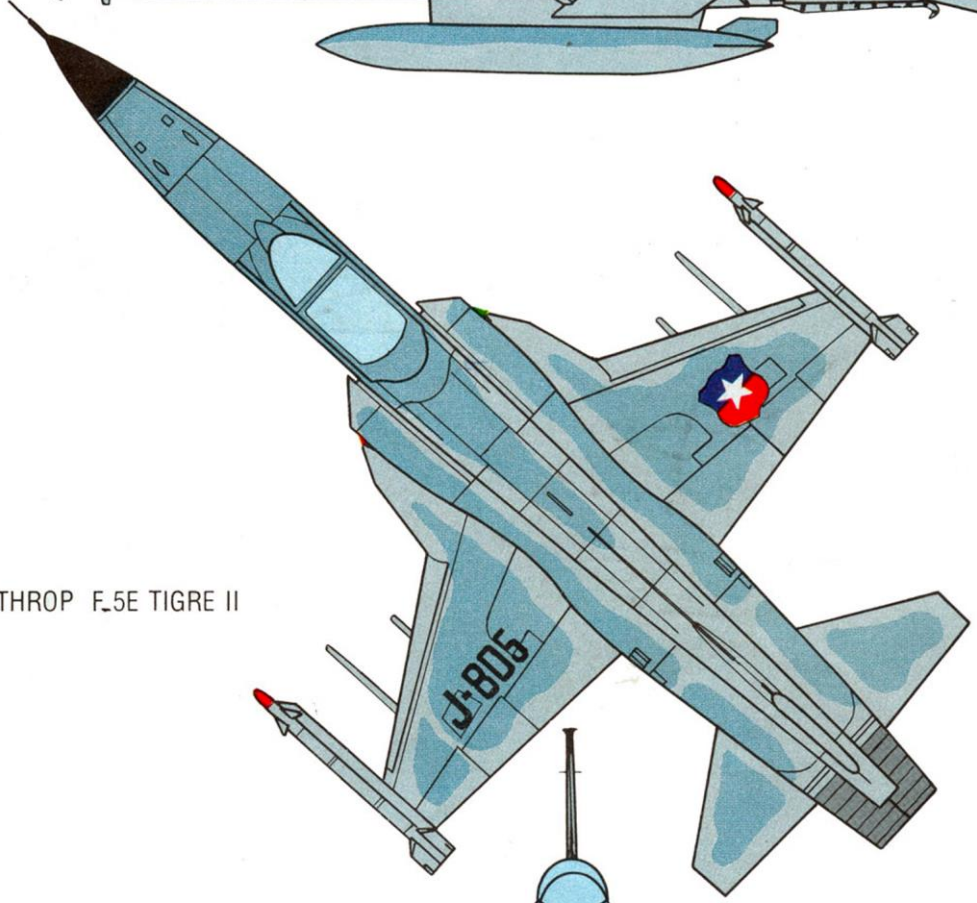
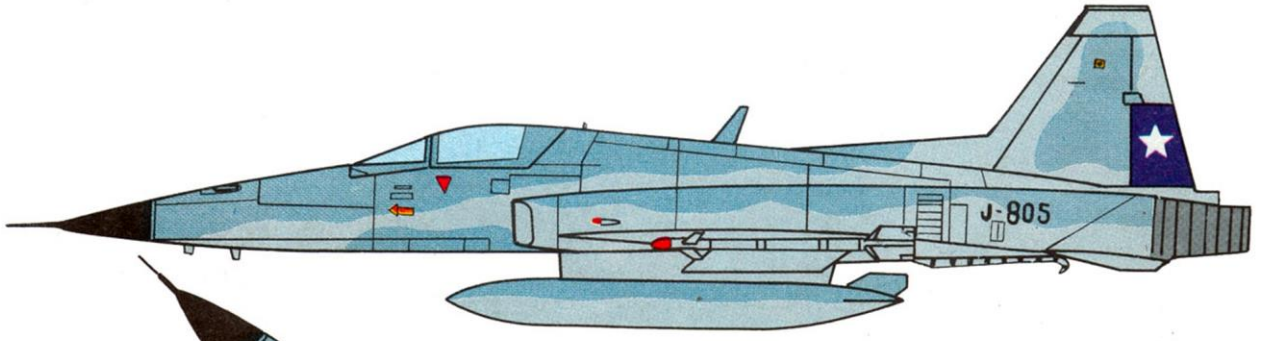
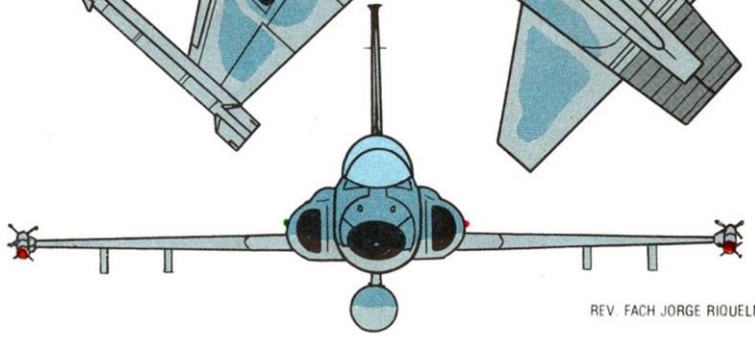

Figure 2.1 F-5E-3 Dimensions



NORTHROP F-5E TIGRE II



REV. FACH JORGE RIQUELME G.

3 AIRCRAFT DESIGN

3 AIRCRAFT DESIGN

General

The F-5E is a single-seat, aft tail aircraft with a tapered low wing. Two turbojet engines (17) equipped with afterburners are located in the fuselage tail section. The wing, horizontal tail (12), and vertical stabilizer (13) are moderately sweptback. Each wing is equipped with leading and trailing edge flaps used to improve takeoff, landing and maneuvering performance, as well as increase flight range and duration. An improved shark nose radome design and leading edge wing extensions have increased high angle-of-attack stability.

The aircraft general arrangement drawing shows location of major aircraft structural components, systems and accessories. In case of battle damages to certain areas, if you are aware of the arrangement of aircraft elements, particular failures may be expected.



Figure 3.1 General Arrangement

- | | |
|-----------------------------|------------------------------------|
| 1. PITOT-STATIC BOOM | 16. VARIABLE EXHAUST NOZZLE |
| 2. RADAR ANTENNA | 17. ENGINES |
| 3. AVIONICS EQUIPMENT BAYS | 18. ENGINE AUX INTAKE DOOR |
| 4. GUNS | 19. R FUEL(AFT) SYSTEM CELLS |
| 5. COMPUTING OPTICAL SIGHT | 20. LEADING EDGE WING EXTENSION |
| 6. EJECTION SEAT | 21. L FUEL (FWD) SYSTEM CELL |
| 7. ELECTRICAL EQUIPMENT BAY | 22. ENGINE AIR INLET DUCT |
| 8. LEADING EDGE FLAP | 23. NOSEWHEEL STEERING SYSTEM |
| 9. AILERON | 24. LAUNCHER RAIL |
| 10. TRAILING EDGE FLAP | 25. OUTBOARD PYLON |
| 11. HYDRAULIC RESERVOIRS | 26. INBOARD PYLON |
| 12. HORIZONTAL TAIL | 27. LANDING-TAXI LIGHTS (EXTENDED) |
| 13. VERTICAL STABILIZER | 28. CENTERLINE PYLON |
| 14. RUDDER | 29. COUNTERMEASURES DISPENSER |
| 15. DRAG CHUTE COMPARTMENT | 30. ARRESTING HOOK |

Fuselage

The fuselage is mainly made of lightweight alloys while steel, titanium and nickel alloys are implemented only in certain areas. The fuselage consists of a radar-transparent radome, gun bay (1), cockpit (2), fuel compartment (3), engine compartment (5), and various equipment bays (5).

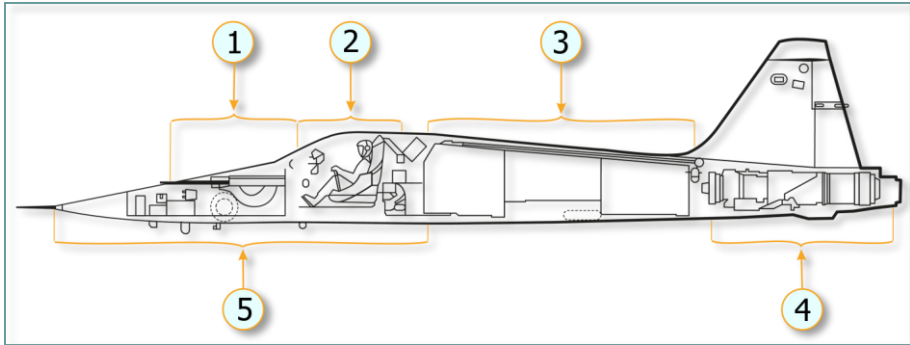

Figure 3.2 F-5E Fuselage

- | | |
|---------------------|-----------------------|
| 1. GUN BAY | 4. ENGINE COMPARTMENT |
| 2. COCKPIT | 5. AVIONICS BAYS |
| 3. FUEL COMPARTMENT | |

The ventral portion of the fuselage includes landing gear wells. Various antennas, sensors, and equipment ensuring operation, survivability, and combat efficiency of the fighter are mounted on the fuselage.

Cockpit

The cockpit is equipped with air-conditioning and pressurization systems. Bleed Air from the engines compressor is diverted to pressurize the cabin.

The cockpit contains the ejection seat, aircraft and armament controls, various instruments and control panels of various aircraft systems. The canopy opens backward-upward.



Wing

Multispar thick skin wings incorporate leading edge extensions. Dihedral and wing setting angles are 0° , sweepback at leading edge is 32° . Each wing is equipped with a flap system used to improve maneuvering, takeoff and landing performance. The flap system consists of leading and trailing edge flaps (maximum setting angles are 24° and 20° , respectively). For roll control purposes, the wing is equipped with ailerons having a maximum deflection of 35° up and 25° down.



Wing leading edge extension. (Flaps fully retracted - UP position)



Flaps fully extended – FULL position



Aileron

The flaps are controlled by a **FLAP LEVER (1)** behind the throttles and by a **THUMB SWITCH (2)** on the right throttle.

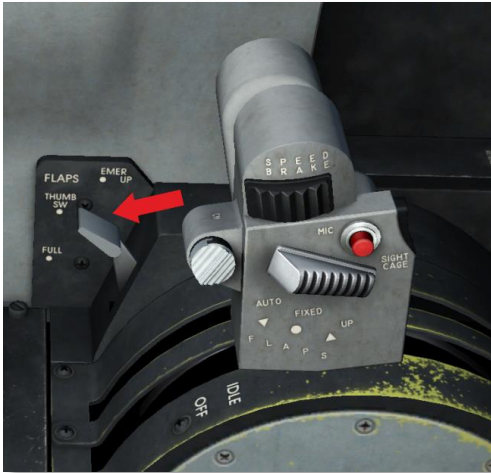

1. Flap Lever
 |LShift + D| - FULL position;
 |LCtrl + D| - EMER UP position;
 |D| - THUMB SW position.

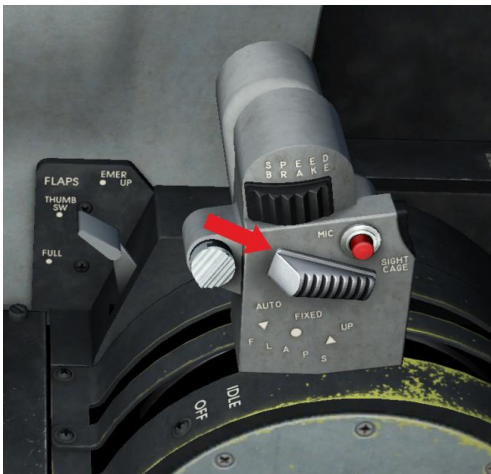

2. Flap Thumb Switch
 |F| - AUTO position;
 |LAlt + F| - FIXED position;
 |LShift + F| - UP position.

The ailerons are controlled by moving the control stick laterally. Maximum deflection angle of the aileron depends on landing gear position.

Speed Brake System

Two hydraulically-actuated speed brakes are located forward of main gear wells and has a full extension of 45°.



Speed brake closed (IN)



Speed brake open (OUT)

The speed brakes are controlled by a three position switch (IN – NEUTRAL – OUT) on the right throttle.



Air Brake Switch

In game, controlled by:
 |B| – change position incrementally
 |LShift + B| – OUT position
 |LCtrl + F| – IN position
 |LAlt + F| – NEUTRAL position

Empennage (Tail)

The empennage comprises a vertical stabilizer (1) with rudder (3) and variable horizontal tail (2). Vertical stabilizer sweep is 35° and horizontal tail sweep is 32° . Maximum rudder travel is $\pm 30^\circ$ (left/right pedal fully down). Maximum horizontal tail travel is 17° up (control stick pulled back) and 5° down (control stick pushed forward). Negative dihedral angle of the horizontal tail is minus 5° .

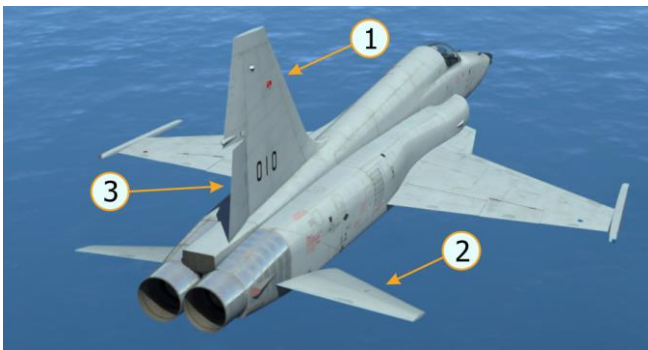

1. Vertical Stabilizer
2. Horizontal Tail
3. Rudder

Landing gear

The aircraft is equipped with a tricycle, single-wheel landing gear. A main gear is retracted into inboard wing panel. A nose gear is retracted forward into the fuselage bottom section. The landing gear is extended and retracted by a hydraulic system. In the event of failure, there is an alternate release of

the landing gear, in this case, retraction of the gear is assisted by gravity and airloads.



Landing gear during extension (doors have not been closed yet)

The nose gear is equipped with a nosewheel steering system. Nosewheel steering is engaged when the steering button on the control stick is depressed [**S**]. The rudder pedals are used to actuate/turn the nosewheel (**|Z** - left, **|X** - right). When the nosewheel steering system is disengaged, the nosewheel swivels freely. The nose gear strut has two height positions. It can be lengthened (hiked) using a [NOSE STRUT Switch](#) in the cockpit, such increase in strut height adds 3° to the pitch attitude (angle-of-attack), thus shortening takeoff ground run. The strut automatically shortens (dehikes) before it enters the wheel well.

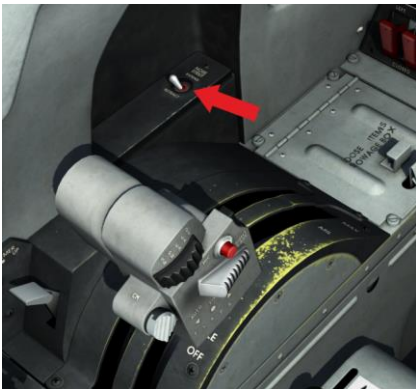

NOSE STRUT Switch

In game, controlled by:
|LAlt + LCtrl + Q|

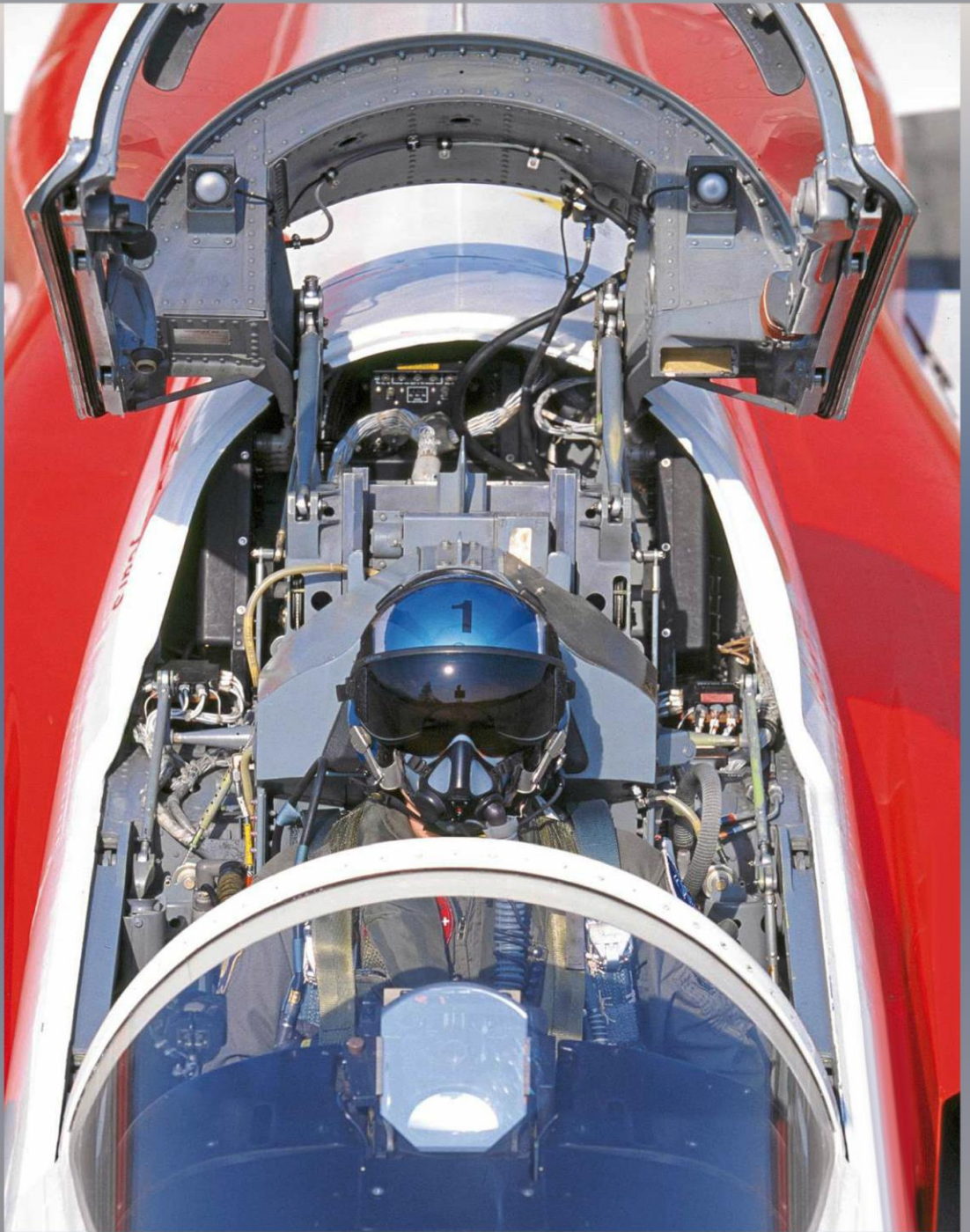

4 COCKPIT

4 COCKPIT

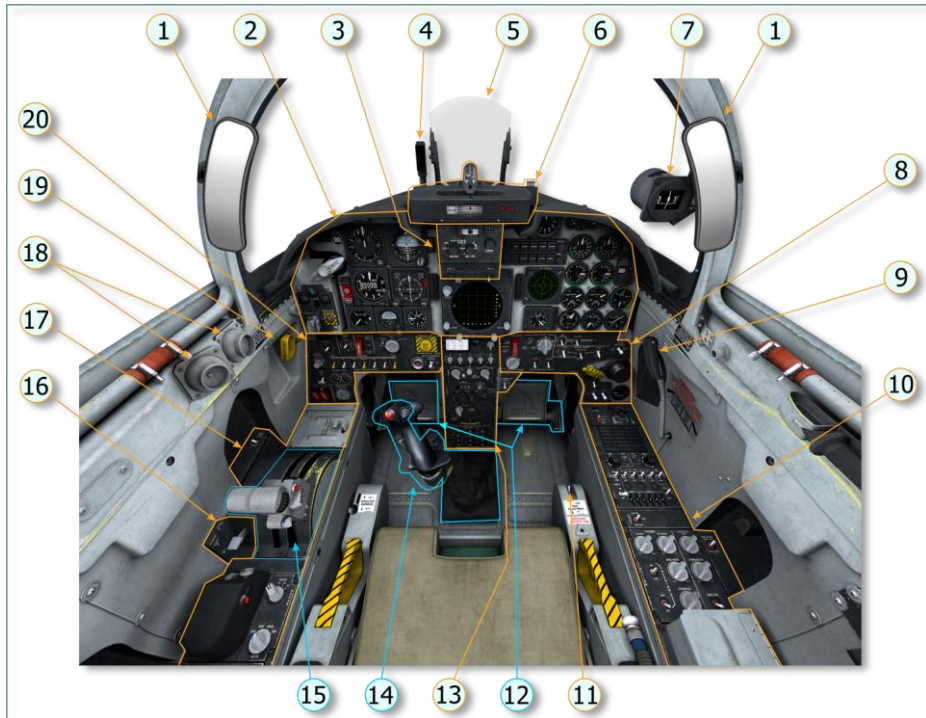
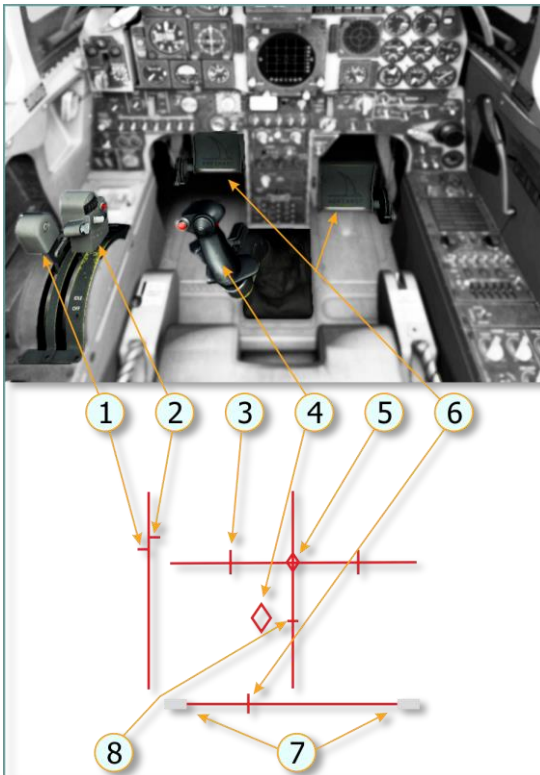

Figure 4.1 Кабина F-5E-3

- | | |
|--|---|
| 1. MIRROR (EACH SIDE) | 11. SEAT ADJUST SWITCH |
| 2. INSTRUMENT PANEL | 12. PEDALS |
| 3. COMPUTING OPTICAL SIGHT | 13. PEDESTAL |
| 4. ANGLE-OF-ATTACK INDEXER | 14. CONTROL STICK |
| 5. SIGHT REFLECTOR | 15. THROTTLES (L&R) |
| 6. SIGHT CAMERA | 16. FLAP LEVER |
| 7. MAGNETIC COMPASS | 17. LEFT CONSOLE |
| 8. RIGHT VERTICAL PANEL | 18. CONDITIONED AIR INLETS |
| 9. CANOPY HANDLE | 19. LANDING GEAR ALTERNATE RELEASE HANDLE |
| 10. RIGHT CONSOLE | 20. LEFT VERTICAL PANEL |

4.1 Aircraft controls

The pilot exercises control over the aircraft both on the ground and in flight by means of a control stick, throttles and pedals. Flight controls are defined by the use of the rudder and stick. Throttles are used for engine management.



1. Left Throttle and Position Indication
2. Right Throttle and Position Indication
3. Aileron Spring Stop
4. Control Stick and Position Indication
5. Trim Tab Position (mechanism used to reduce pressure on control stick)
6. Pedals and Rudder Pedal Indicator
7. Wheel Brake pressure Indicator
8. Maximum Pitch Trim Deviation Indicator

Before takeoff, the pitch trim indicator (5) shall be set approximately to a middle position

In cockpit view, a gamer (user) can toggle aircraft control indication window using [[RCtrl](#) + [Enter](#)]. The indicator appears in the bottom left side of the screen.

Control stick

The purpose of the aircraft control stick is to manipulate the aircraft's orientation in the form of pitch and roll. Roll is used to turn the aircraft while pitch is used to control altitude.



1. Pitch and Aileron Trim Button
`|RCtrl + .|` – pull
`|RCtrl + ;|` – push
`|RCtrl + '|` – move left
`|RCtrl + /|` – move right
2. Bomb-Rocket Button
`|RAlt + Space|`
3. Pitch Damper Cutoff Switch `|A|`;
4. Nosewheel steering button `|S|`;
5. Radar mode selector switch;
6. Trigger – fires gun, launches missile, runs camera `|Space|`

Throttle

The throttle provides control over engine thrust, thus, is used to control flight speed. Each throttle controls its respective engine. For the convenience of the pilot, the throttle contains control buttons of different systems.

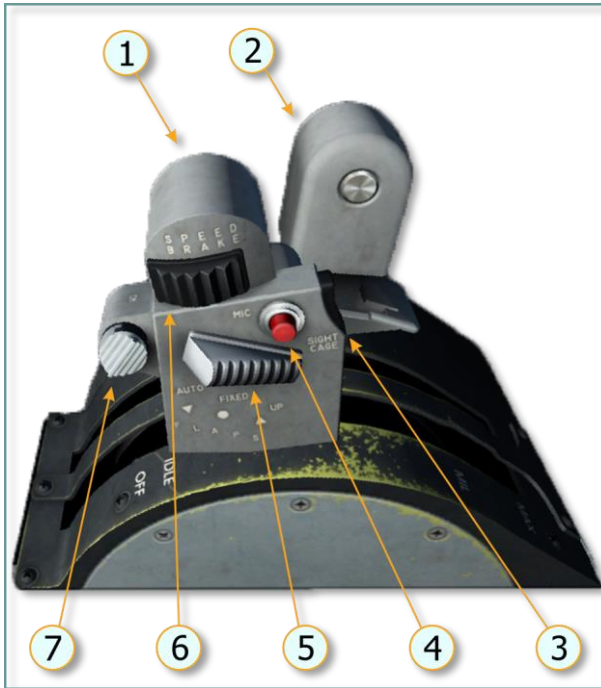

1. Right Throttle
2. Left Throttle
3. Sight Cage Button
4. Microphone Button
5. Flap thumb Switch
6. Speed Brake Switch
7. Chaff/Flare Release Button

Rudder pedals

With the nosewheel steering button pressed and held **[S]**, nosewheel steering is controlled by movement of the rudder pedals. Nosewheel steering is available when the aircraft weight is on the right main gear. When the nosewheel steering button is released, the system provides viscous shimmy damping capability.

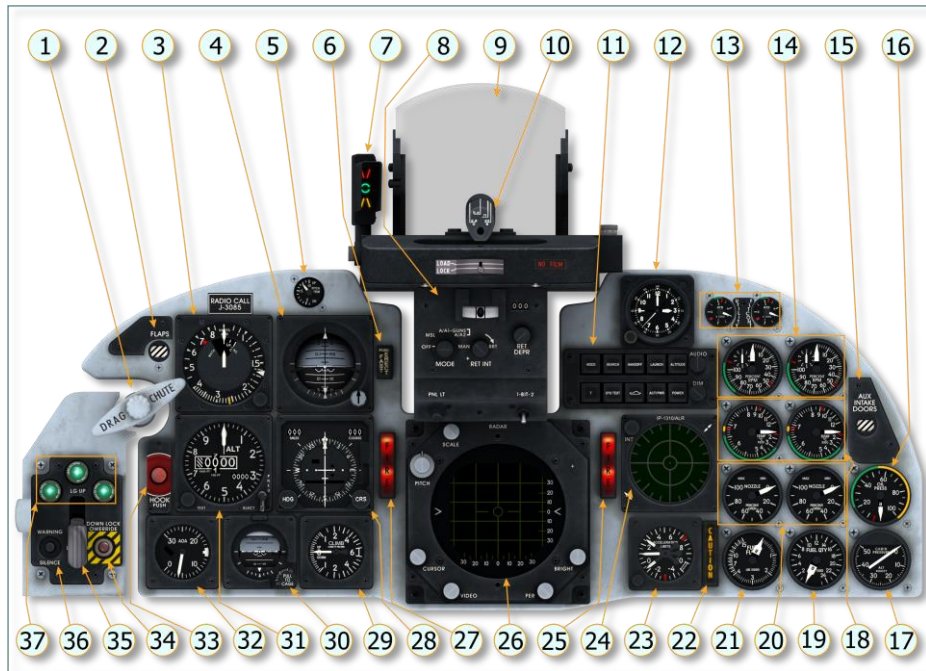
4.2 INSTRUMENT PANEL**Figure 4.2 F-5E-3 Aircraft Instrument Panel**

1. [DRAG CHUTE T-HANDLE](#)
2. [FLAP POSITION INDICATOR](#)
3. [AIRSPEED/MACH INDICATOR](#)
4. [ATTITUDE INDICATOR](#)
5. [PITCH TRIM INDICATOR](#)
6. [ATTITUDE INDICATOR FAST-ERECT SWITCH](#)
7. [ANGLE-OF-ATTACK INDEXER](#)
8. [COMPUTING OPTICAL SIGHT](#)
9. [SIGHT REFLECTOR](#)
10. [SIGHT CAMERA](#)
11. [RWR INDICATOR CONTROL](#)
12. [CLOCK](#)
13. [HYDRAULIC PRESSURE INDICATORS](#)
14. [ENGINE TACHOMETERS](#)
15. [AUX INTAKE DOORS INDICATOR](#)
16. [OIL PRESSURE INDICATOR \(DUAL\)](#)
17. [CABIN PRESSURE ALTIMETER](#)
18. [EXHAUST GAS TEMPERATURE INDICATORS](#)
19. [FUEL QUANTITY INDICATOR \(DUAL\)](#)
20. [NOZZLE POSITION INDICATORS](#)
21. [FUEL FLOW INDICATOR \(DUAL\)](#)
22. [MASTER CAUTION LIGHT](#)
23. [ACCELEROMETER](#)
24. [RWR AZIMUTH INDICATOR](#)
25. [FIRE WARNING LIGHT \(right engine\)](#)
26. [RADAR INDICATOR](#)
27. [FIRE WARNING LIGHT \(left engine\)](#)
28. [HORIZONTAL SITUATION INDICATOR](#)
29. [VERTICAL VELOCITY INDICATOR](#)
30. [STANDBY ATTITUDE INDICATOR](#)
31. [ALTIMETER](#)
32. [ANGLE-OF-ATTACK INDICATOR](#)
33. [ARRESTING HOOK BUTTON](#)
34. [LANDING GEAR DOWNLOCK OVERRIDE BUTTON](#)
35. [LANDING GEAR LEVER](#)
36. [LANDING GEAR AND FLAP WARNING SILENCE BUTTON](#)
37. [LANDING GEAR POSITION INDICATOR LIGHTS](#)

4.3 Instrument panel indicators and instruments

This section contains brief description of indicators and instruments located on the instrument panel with links to description of relevant system operation where necessary.

Flap Position Indicator



Flaps fully retracted



Flaps position depends on angle of attack and flight speed [AUTO Flaps](#)



Flaps in intermediate position



Flaps position depends on flight speed and altitude [FXD Flaps](#)



Flaps fully extended

AVU-8 Airspeed/Mach Indicator

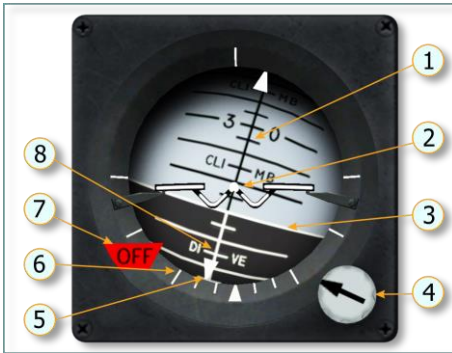

1. Airspeed dial
2. Airspeed Index (should be manually set)
3. Airspeed Index Set Knob
4. Maximum Landing Gear Extended Speed Index
5. Airspeed and Mach Number Pointer
6. Mach Number Dial
7. Maximum Allowable Indicated Airspeed Pointer

ARU-20/A Attitude Indicator

1. Pitch Reference Scale (climb)
2. Miniature Aircraft (indicates aircraft attitude)
3. Horizon Bar
4. Pitch Trim Knob (should be adjusted on the ground)
5. Bank Pointer
6. Bank Scale
7. OFF flag
8. Pitch Reference Scale (dive)

The indicator shows aircraft pitch and roll attitude through a full 360 degrees.

If temporary power failure occurs during maneuvering (not in straight and level flight), thus causing the OFF flag to appear, the vertical gyro may tilt and pitch and roll readings of the instrument will be incorrect. In order to return the instrument into operating condition, press the **FAST-ERECT** switch located on the instrument panel.



Note. Corrections must be made in level (horizontal) flight without acceleration.

Attitude and reference heading system (AHRS) pitch and roll data indicated on the instrument are also sent to the weapons system, particularly to the radar indicator and optical sight.

Pitch Trim Indicator

The instrument indicates trim position. On aircraft controls position indicator (**|RCtrl + Enter|**) there is mark corresponding to 10 increments nose up position.

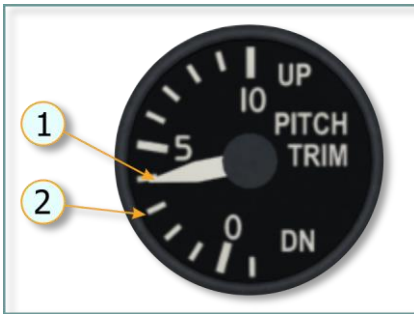

1. Pitch Trim Pointer
2. Pitch Trim Dial:
0 – neutral position
0 to 10 – nose-up trim
0 to -1 – nose-down trim.

Angle-Of-Attack Indexer

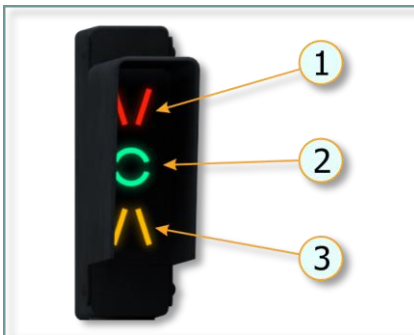

1. Slow speed
2. On Speed
3. Fast speed

Simultaneous illumination of two symbols, for example green and yellow, means that the speed is slightly fast; green and red, the speed is slightly slow.

Clock



1. Flight Timer START Button
2. Minute Hand
3. Hour Hand
4. Timer Second Hand.
5. Clock Winding and Setting Knob
6. Timer Minute Hand

Time can be set by depressing left mouse button (5) and scrolling mouse wheel. Winding is made by depressing right mouse button (6) and scrolling mouse wheel.

Hydraulic Pressure Indicators



1. 4. Operating Range of Flight Control (right indicator) and Utility (left indicator) Hydraulic Systems
2. 3. Minimum Pressure of Flight Control and Utility Hydraulic Systems (caution light illumination)

Engine Tachometers (L&R)



1. Minimum Idle RPM
2. Engine RPM Dial (graduated in increments of 2 %)
3. Continuous RPM (corresponds to maximum continuous power of engine)
4. Maximum Permissible RPM at Military (MIL) or Afterburner (AB) Power (during acceleration)
5. Engine RPM dial (graduated in increments of 1 %)

Aux Intake Doors Indicator



Intake doors are fully closed



Any of the following:
Intake doors are at intermediate position;
One intake door is open, the other is closed;
AC power is not available.



Intake doors are fully open

Oil Pressure Indicator (Dual)

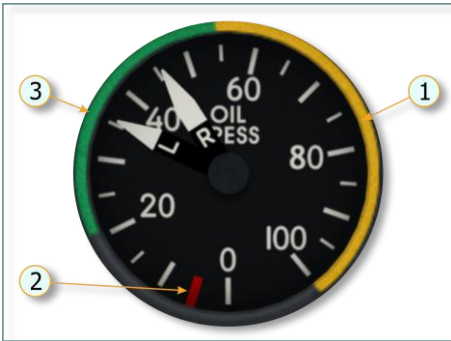

1. Excessive Oil Pressure Range
2. Minimum Oil Pressure at Idle
3. Normal Oil Pressure range

When starting the engine in cold weather conditions, excessive oil pressure may be observed (the colder the oil the higher its viscosity). After engine start, the oil will warm up and its pressure should fall below 55 psi. Do not operate the engine at excessive pressure for more than 6 minutes.

Note: The oil pressure may fluctuate within 10 psi at stabilized rpm. The oil pressure may drop to 0 psi during maneuvering and recover subsequently.

Cockpit Pressure Altimeter

1. Indicates cockpit pressure altitude (ft).

Note: Cockpit pressure altitude in the pressurized cockpit differs from altitude indicated on the altimeter by the value of differential pressure (cockpit pressure altitude is lower due to operation of a pressurization system). In case of decompression, cabin pressure altitude will not differ from altitude on the altimeter.

Exhaust Gas Temperature Indicators (L&R)

1. Maximum Temperature during Start and Acceleration.
2. Minimum Temperature at Idle
3. Continuous Operation Temperature Range
4. Temperature Range Allowable Under Limited Conditions (time-limited)
5. Maximum Temperature at MIL or AB Power

Fuel Quantity Indicator (dual)

1. Remaining Fuel in Left Engine Fuel System
2. Remaining Fuel in Right Engine Fuel System

Nozzle Position Indicators (L&R)

1. Nozzle Position (indicated in percent of fully open position)

Note: When the pointer is against 100 %, the nozzle is fully open (in accordance to nozzle operation schedule, i.e. the nozzle is at mechanical stops for fully opened position); 0 % - nozzle diameter is minimum (at mechanical stops for fully closed position).

Fuel flow indicator (dual)



1. Left Engine Fuel Flow
2. Right Engine Fuel Flow

Fuel flow is indicated in pounds per hour.

Master Caution Light



Illuminates when any of caution lights comes on, thus attracting pilot's attention to caution light panel. After the master caution light is depressed, it goes down, switches to stand-by mode, and ignores currently activated caution light. Illuminates again whenever a new caution light is activated on the panel.

Accelerometer



1. Maximum Positive G Index
2. Maximum Negative G Index
3. Reset Button (resets maximum positive and negative load pointers)
4. Maximum Attained Negative G-load Pointer
5. Current G-load
6. Maximum Attained Positive G-load Pointer

Horizontal Situation Indicator

- | | |
|--|---|
| 1. Heading Marker (set by HDG set knob) | 11. Aircraft Symbol |
| 2. Course Selector Window (selected by CRS set knob) | 12. Deviation/DF window:
Blank – Indicates valid indications in TACAN mode; |
| 3. Course Arrow (Head) (set by CRS set knob) | Red flag – Indicates loss of electrical power, invalid indications in TACAN mode, or instrument malfunction; |
| 4. OFF Flag | DF – Indicates DF mode operation (uses stations) |
| 5. TO/FROM indicator (bottom triangular window – from the station; upper triangular window – to the station) | 13. Bearing Pointer (Head) (ADF, TACAN) |
| 6. CRS (Course Set Knob) | 14. Range to Selected TACAN Station. Barber pole – Selected station is out of range, electrical power failure, instrument malfunction, or DF mode is selected |
| 7. Bearing Pointer (Tail) | 15. Upper Lubber Line |
| 8. HDG (Heading Set Knob) | |
| 9. Course Arrow (Tail) | |
| 10. Course Deviation Indicator (CDI). When course is in TACAN, the CDI lines against course arrow head. | |

AAU-34/A Altimeter

1. Dial (graduated in 20 and 100-foot increments)
2. Tens and Units of FT (permanently displays 00, the data are indicated by the pointer on dial 1)
3. Pressure (can be set to pressures from 28.10 to 31.00 inches of mercury)
4. Mode Control Lever (lever is spring-loaded in neutral position)
ELECT – Corrected altitude (computed by central air data computer (CADC));
PNEU – Altitude pressure (spring-loaded in neutral position)
5. Pressure Set Knob
6. 100-foot Drum
7. 1000-foot Drum
8. 10000-foot Drum (instrument indicates altitude up to 80,000 feet)
9. PNEU flag (appears in the event of altitude readout error accumulation (possible during transonic flight conditions) or CADC failure. Altimeter indicates uncorrected pressure altitude.)

Note: Altitude readout error accumulation may occur during transonic flight condition. In this case, the altimeter reverts to a standby mode (pressure altitude), i.e. the altitude is indicated with error. The CADC mode of operation should be resumed by momentarily positioning the mode control lever (4) to ELECT position.

Standby Attitude Indicator

The standby attitude indicator is a self-contained in-dicator that provides a visual indication of the bank and pitch of the aircraft and should be used

when the attitude indicator or AHRS fails. The pitch limits are 92 degrees in climb, 78 degrees in dive, and the roll capability is a full 360 degrees.

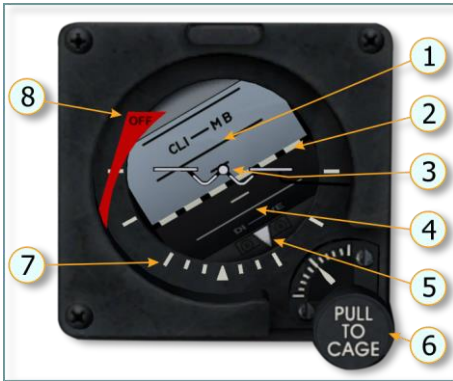

1. Pitch Reference Scale (Climb)
2. Horizon Bar
3. Miniature Aircraft
4. Pitch Reference Scale (Dive)
5. Bank Pointer
6. PULL TO CAGE/Pitch Trim Knob (trim adjustment when in pushed in position, gyro erection to true vertical when in pulled out position)
7. Bank Scale
8. OFF flag

Approximately 3 minutes are required to erect to true vertical after power is applied to the system. The indicator should be caged and locked before power is applied to the system, uncaged and set following engine start and left uncaged for the remainder of the flight. It should be caged and locked prior to removing power from the system. The standby attitude indicator is powered by the 28-volt dc bus. When power is interrupted or the indicator is caged, the OFF warning flag appears on the face of the indicator. Approximately 9 minutes of useful attitude information is provided after power failure.

Angle-Of-Attack Indicator



1. AOA (Angle-of-Attack) Dial - Calibrated in units. Units are corrected AOA value and differ from real AOA degrees.
2. On-Speed Index - Optimum angle-of-attack for landing approach with gear and flaps down.
3. AOA Pointer - Indicates actual angle-of-attack
4. OFF Flag - Appears when electrical power is removed.

The indicator shows the value of the angle-of-attack in units from 0 to 30. Units are a corrected AOA value and differ from real AOA degrees.

Vertical Velocity Indicator



1. Rate of Climb Dial
2. Rate of Descent Dial

Rate of climb/descent is indicated in feet per minute.

Note: Due to design features of the instrument, its indications are slightly lagging. For this reason, climb, descent and level flight conditions shall be determined according to readings of the attitude indicator with reference to the vertical velocity indicator.

4.4 LEFT VERTICAL PANEL

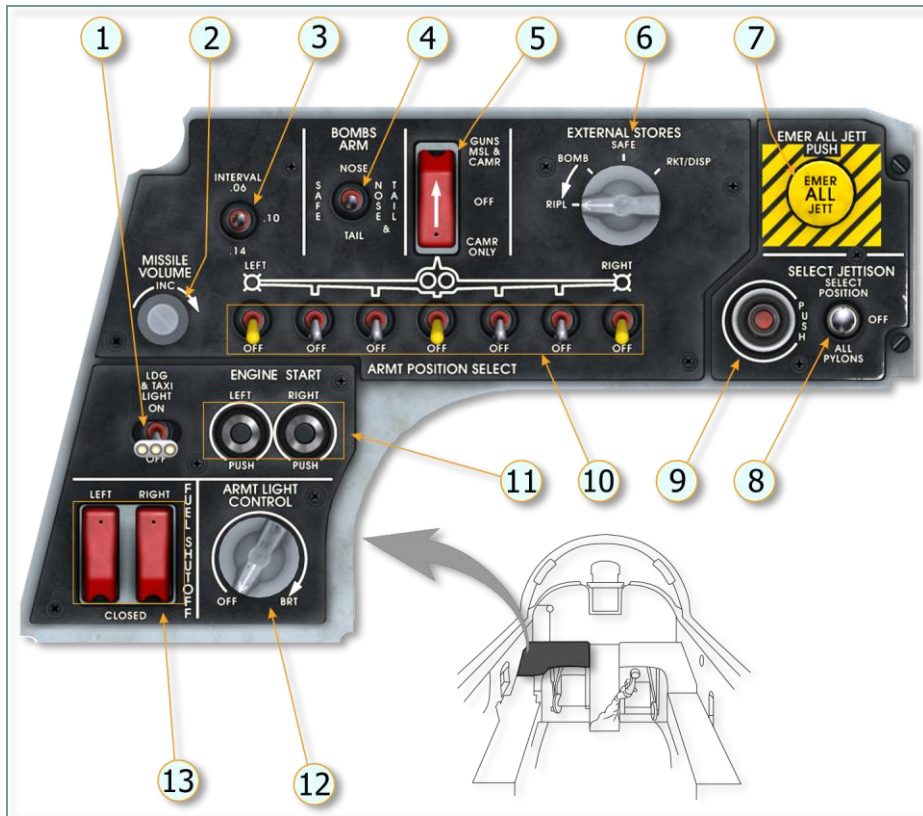

1. LANDING & TAXI LIGHT SWITCH
2. MISSILE VOLUME KNOB
3. INTERVAL SWITCH
4. BOMBS ARM SWITCH
5. GUNS, MISSILE, AND CAMERA SWITCH
6. EXTERNAL STORES SELECTOR
7. EMERGENCY ALL JETTISON BUTTON

8. SELECT JETTISON SWITCH
9. SELECT JETTISON BUTTON
10. ARMAMENT POSITION SELECTOR SWITCHES (7)
11. ENGINE START BUTTONS
12. ARMAMENT PANEL LIGHTS KNOB
13. FUEL SHUTOFF SWITCHES

4.5 RIGHT VERTICAL PANEL

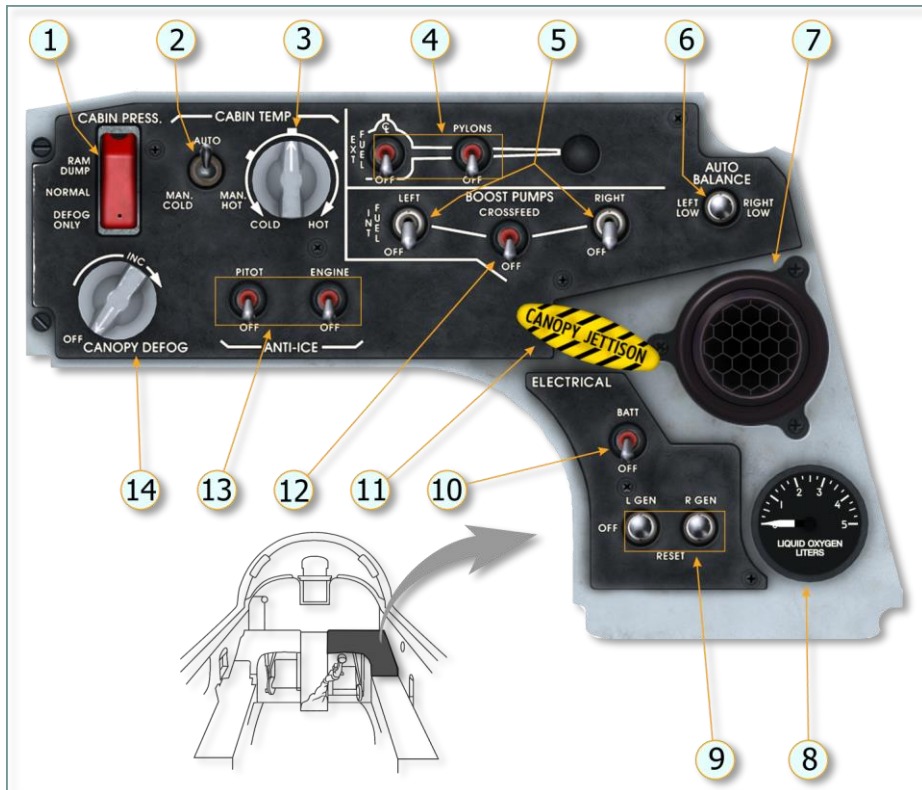

- | | |
|---|--|
| <ol style="list-style-type: none"> 1. COCKPIT PRESSURIZATION SWITCH 2. COCKPIT TEMPERATURE SWITCH 3. COCKPIT TEMPERATURE KNOB 4. EXTERNAL FUEL TRANSFER SWITCHES 5. BOOST PUMP SWITCHES 6. AUTOBALANCE SWITCH 7. COCKPIT AIR INLET | <ol style="list-style-type: none"> 8. OXYGEN QUANTITY INDICATOR 9. GENERATOR SWITCHES 10. BATTERY SWITCH 11. CANOPY JETTISON T-HANDLE 12. CROSSFEED SWITCH 13. ENGINE ANTI-ICE SWITCH AND PITOT HEAT SWITCH 14. CANOPY DEFOG KNOB |
|---|--|

4.6 LEFT CONSOLE PANEL

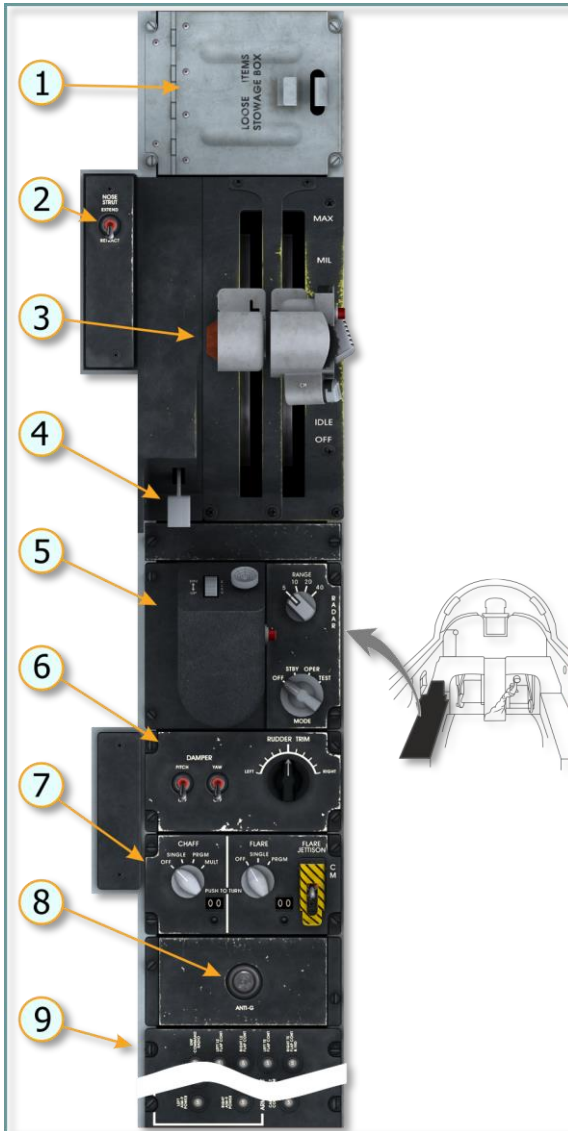

1. LOOSE ITEMS STORAGE BOX
2. NOSE STRUT SWITCH
3. THROTTLES
4. FLAP LEVER
5. RADAR CONTROL PANEL
6. STABILITY AUGMENTER CONTROL PANEL
7. COUNTERMEASURES DISPENSER CONTROL PANEL
8. ANTI-G SUIT TEST BUTTON
9. CIRCUIT BREAKER PANEL

4.7 RIGHT CONSOLE PANEL

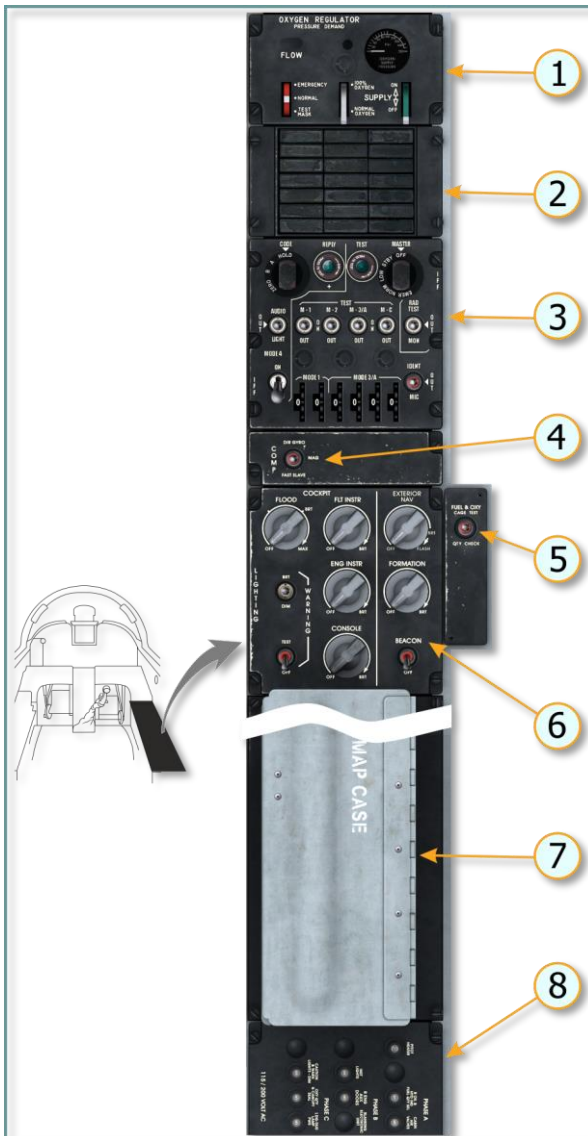

1. OXYGEN REGULATOR
2. CAUTION LIGHT
PANEL
3. IFF/SIF CONTROL
PANEL
4. COMPASS SWITCH
5. FUEL AND OXYGEN
SWITCH
6. LIGHTING CONTROL
PANEL
7. MAP CASE
8. CIRCUIT BREAKER
PANEL

4.8 PEDESTAL PANEL

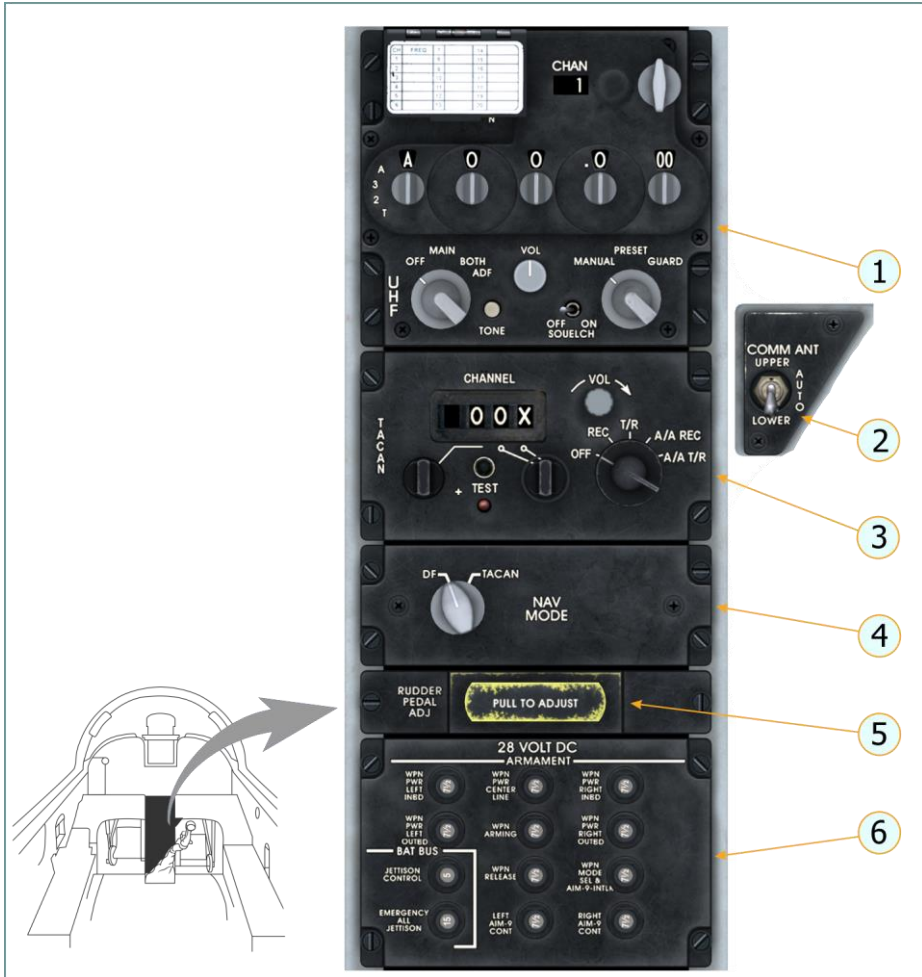

- | | |
|--|---|
| <ul style="list-style-type: none"> 1. UHF RADIO CONTROL PANEL 2. ANTENNA SELECTOR SWITCH 3. TACAN CONTROL PANEL 4. NAVIGATION MODE CONTROL PANEL | <ul style="list-style-type: none"> 5. RUDDER PEDAL ADJUSTMENT T - HANDLE 6. CIRCUIT BREAKER PANEL |
|--|---|

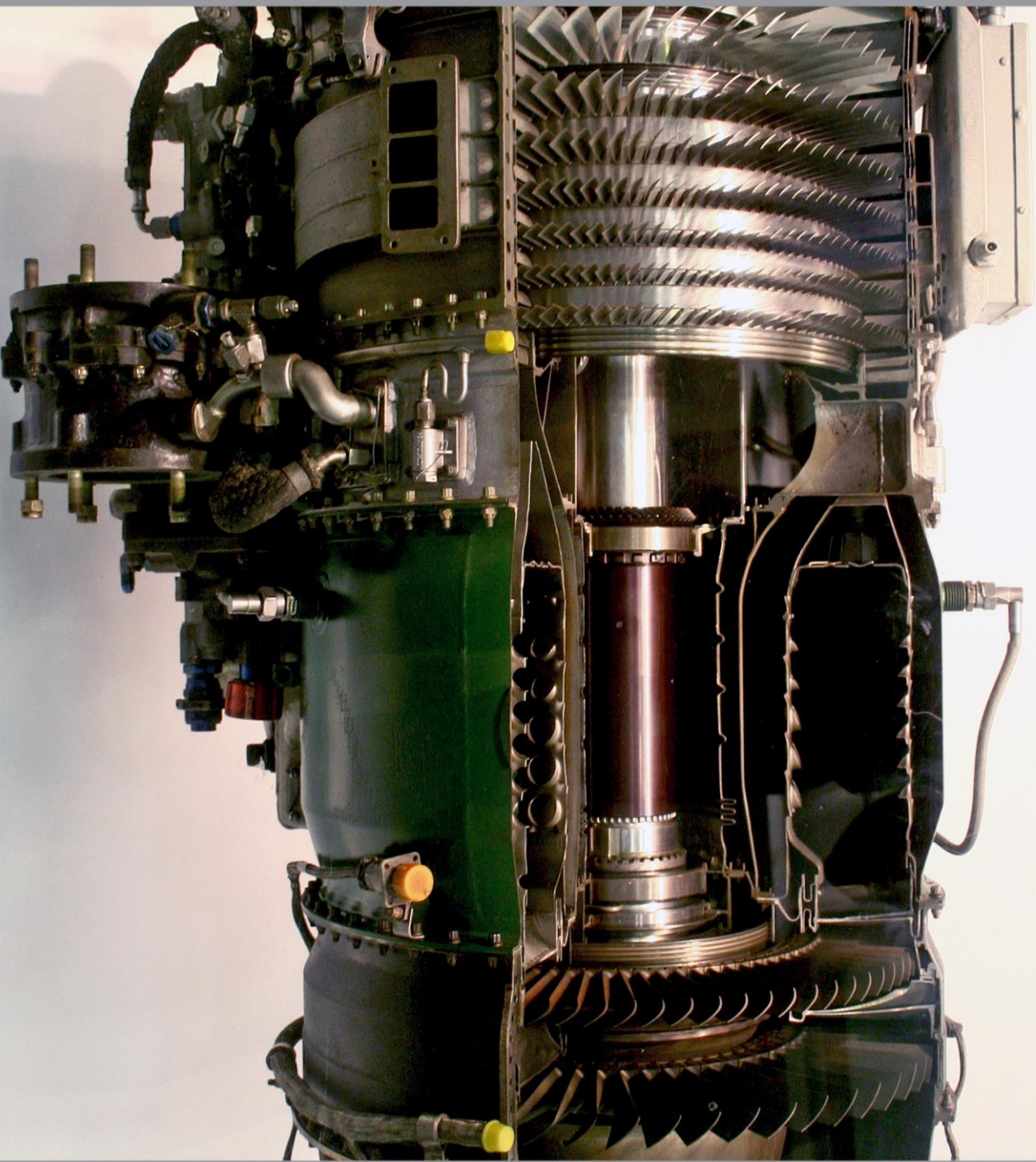

5 ENGINE

5 J85-GE-21 ENGINE

The aircraft is powered by two J85-GE-21 turbojet engines equipped with afterburners.

Sea level, standard day, static thrust at military (MIL) power is 3250 pounds (1475 kgf) and at maximum afterburner (MAX) power, 4650 pounds (2110 kgf).

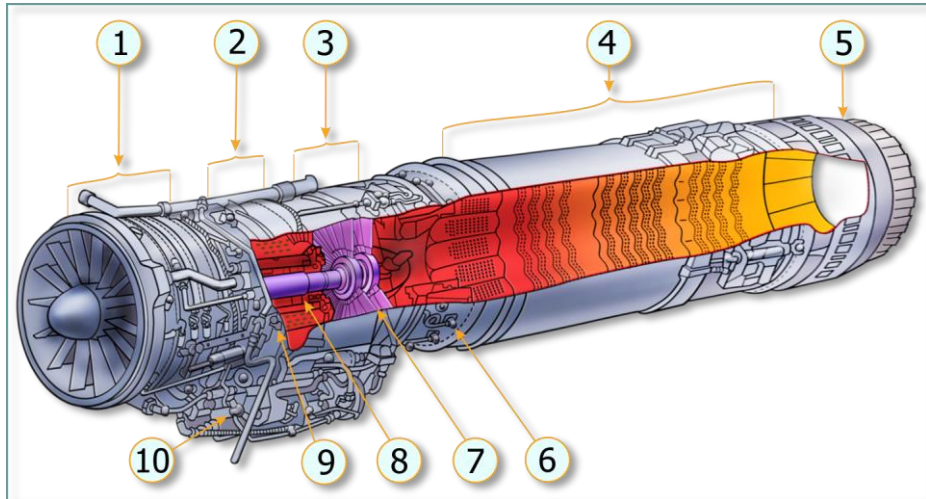

Figure 5.1 J85-GE-21 Engine Cut-Away View

- | | |
|----------------------------|-----------------------------------|
| 1. COMPRESSOR SECTION | 6. AFTERBURNER MAIN FUEL MANIFOLD |
| 2. COMBUSTOR SECTION | 7. TURBINE |
| 3. TURBINE SECTION | 8. ROTOR |
| 4. AFTERBURNER SECTION | 9. FUEL NOZZLES |
| 5. VARIABLE EXHAUST NOZZLE | 10. ENGINE ACCESSORY GEARBOX |

Compressor (1)

Air enters into a compressor through air inlet ducts located on the both sides of the fuselage.

The nine-stage compressor is equipped with variable stator vanes that reduce the possibility of a compressor stall. Turning of the variable vanes is simulated in the game. This has a significant effect on simulation of the idle power and engine starting. Inlet guide vanes are heated by hot air to prevent their icing.

In addition, compressed hot air bled from the compressor provides heating of the fuselage nose (with the radar antenna) and canopy windshield. Cooled compressor bleed air provides pressurization to the anti-G suit and external fuel tanks. Air bleed is also simulated during compressor operation.

Turbine (7)

The compressor is coupled directly with a two-stage turbine. Exhaust gases from the combustor section passes through the turbine and drives the engine rotor, afterwards, the hot gases are dumped into a variable exhaust nozzle.

Variable Exhaust Nozzle (5)

A variable exhaust nozzle control system maintains EGT within allowable limits in MIL and afterburner (AB) power ranges and provides required thrust throughout the operating power range from IDLE to MAX. [Figure 5.3](#)

Accessory Gearbox (10)

Each engine is equipped with an accessory gearbox that operates a hydraulic pump and an AC generator. Automatic gearbox shift occurs in the 68 % to 72 % engine rpm range.

5.1 Auxiliary intake doors

Auxiliary (aux) intake doors on each side of the fuselage above the wing trailing edge provide additional air to the engines for added thrust during takeoff and low-speed flight (low dynamic pressure).

The doors are automatically controlled by a signal from the central air data computer (CADC). An aux intake doors indicator on the instrument panel provides an indication of closed, intermediate, or open position of the doors.

[Aux Intake Doors Indicator](#)

During engine start, the auxiliary intake doors open after each individual generator comes on the line (48 % rpm). After takeoff, the doors close at approximately mach 0.4 (255 ± 10 KIAS). During descent and landing pattern entry, the doors open at approximately mach 0.375 (235 ± 5 KIAS).

Upon loss of AC power, the doors move to closed position as the doors are spring-loaded closed and actuated open.

Note:

- If the doors fail in the close position during takeoff roll, a thrust loss of approximately 7 percent and a corresponding increase in takeoff ground run should be expected.
- If the doors fail in the open position in flight at Mach over 0.4, an increase in fuel consumption of up to 10 percent, depending on flight conditions, may occur.
- If the aux intake doors fail in the close position during deceleration to Mach lower than 0.375, the most probable effect is upon landing pattern entry and the subsequent pattern, approach, and landing. With this condition, the approximate thrust loss of 7 percent should be kept in mind for possible go-around or missed approach power requirements

The thrust loss is implemented in this DCS module for the cases when the aux intake doors are in abnormal position.

5.2 Ignition system

The ignition system uses AC-power for starting the engines on the ground or during flight.

The ignition system for each engine consists of:

- Start button;
- Ignition circuit with 40-second timer;
- Main igniters;
- Afterburner igniters.

AC power can be provided to the system by an external electrical power unit, aircraft generator power (after engine start), or aircraft battery powered static inverter (prior to engine start).

5.3 Engine Controls / Indicators

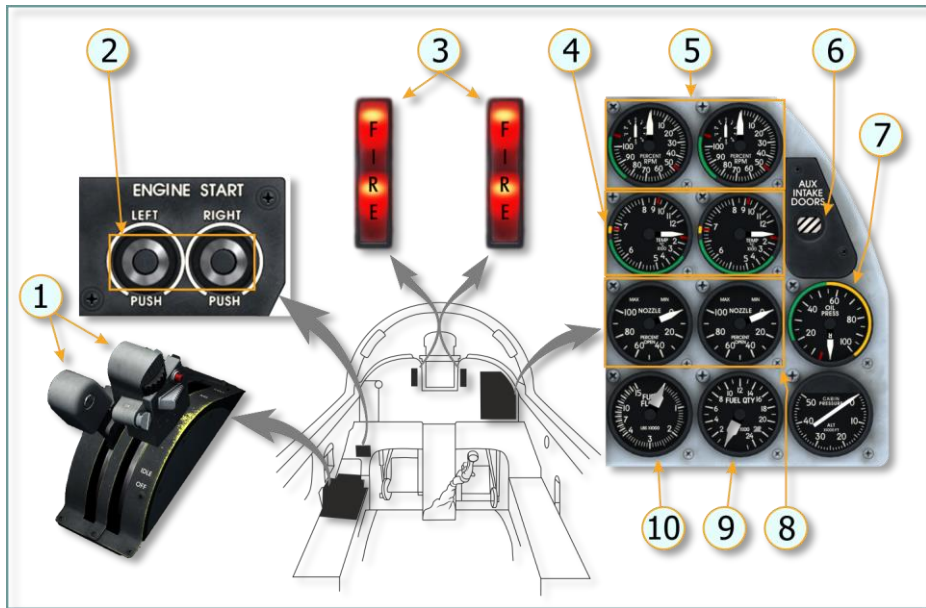

Figure 5.2 Engine Controls/Indicators in Cockpit

No.	Element	Function
1.	Throttles (L&R)	Controls fuel flow into combustor.
2.	ENGINE START Buttons (LEFT and RIGHT)	Momentarily pushing button for selected engine electrically arms ignition circuit and allows ignition timer to run for approximately 40 seconds.
3.	FIRE Warning Lights (RED) (L&R)	Illumination indicates a fire or overheat condition in respective engine compartment.
4.	Exhaust Gas Temperature (EGT) Indicators (L&R)	Indicates engine EGT in °C.
5.	Engine Tachometers (L&R)	Indicates engine rpm from 0 to 110 %.
6.	AUX INTAKE DOORS Indicator	CLOSE – Both intake doors fully closed. OPEN – Both intake doors fully open. Barber Pole: Intake doors in intermediate position; One intake door open, the other intake door closed; DC power is not available
7.	Oil Pressure Indicator-Dual (L&R Pointers)	Indicates engine oil system pressure in psi.

No.	Element	Function
8.	Nozzle Position Indicators (L&R)	Indicates nozzle position in percent of fully open position.
9.	Fuel quantity indicator (Dual) (L&R Pointers)	Indicates quantity of fuel in fuel system of left and right engine.
10.	FUEL FLOW Indicators (L&R)	Indicates fuel flow in PPH (pounds per hour) to each engine.

5.4 Engine Fuel Control System

An engine fuel control system meters the proper amount of fuel to the combustor and afterburner of the engine and effects variable exhaust nozzle opening for stable engine performance throughout its operating range.

[Engine Fuel Control System Schematic diagram](#)

Main Fuel Pump

A rotor-driven main fuel pump is mounted on the engine accessory gearbox and provides high pressure fuel to the automatic fuel control system and also supplies the pressurized fuel into an afterburner fuel control.

Main Fuel Control

A main fuel control consists of computing and metering sections and regulates the fuel flow to the engine to maintain its stable operation throughout the engine operating ranges. Pressurized fuel from the engine-driven fuel pump flows through the main fuel control to the overspeed governor, the oil coolers, pressurizing and drain valve, and is distributed by the main fuel manifold to the 12 main fuel nozzles.

Overspeed Governor

The hydromechanical overspeed governor is provided to limit engine speed to a maximum steady state of about 106 % rpm if the main fuel control fails.

Variable Exhaust Nozzle Operation

Engine rpm depends on throttle position. An automatic control system provides control of engine thrust by varying exhaust nozzle opening diameter up to the MAX power. When throttle is advanced into the afterburner (AB) power range, the automatic control system maintains constant EGT (T5) at $670 \pm 5^\circ\text{C}$ by varying diameter of the nozzle.

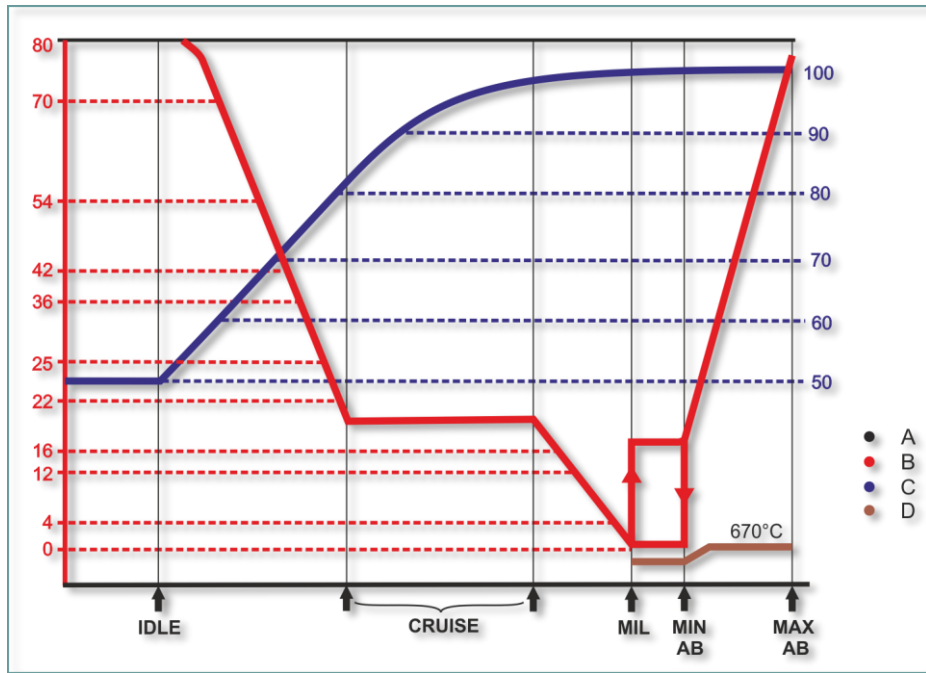

Figure 5.3 Nozzle Operation Schedule

- A. Throttle position
 B. Nozzle position in percent of fully open position
 C. Engine rpm
 D. EGT

Thus, exhaust nozzle position varies depending on throttle position and EGT (T5).

T5 Amplifier System

This system maintains a preset turbine discharge EGT during AB and MIL power operation. If EGT is higher than the preset temperature, the amplifier causes the nozzle to open; if lower, the nozzle closes.

Engine Inlet Temperature (T2)

A T2 sensor is linked with the main fuel control and effects increase/decrease in fuel flow at MIL/AB power (from military to maximum power). As airspeed increases, T2 temperature increases and MIL/AB rpm increases. When inlet temperature (T2) decreases, as in a sustained climb, MIL/AB rpm also

decreases. With T2 temperature of -43 °C and below, MIL/AB rpm may be as low as 90 %.

Afterburner System

Afterburner operation is initiated by advancing throttle beyond MIL mark. Afterburner lightoff on the ground should occur within approximately 5 seconds.

NOTE. The game provides the ability to restrict the movement of the throttles to MIL (imitation of spring detents). To use this feature (spring detent) it is required to assign key in the CONTROL SETTINGS control parameter THROTTLE RANGE (Press to change).

5.5 ENGINE OPERATION

Ground start

Starting the left engine requires an external low-pressure air source for initial motoring of the engine. Right engine is started by using the same external air source or by using compressed air from left engine compressor.

With external ac power applied, battery switch in BATT position, and the engine motoring at 10 % rpm or above, momentarily pushing the start button arms the AC powered ignition circuit and permits the ignition timer to run for approximately 40 seconds. The ignition circuit to the main and after-burner igniters is completed and fuel flow starts to the engine when the throttle is advanced to IDLE. Without external AC power and the battery switch at BATT, a battery powered static inverter activates to provide AC power for engine start when the start button is pushed. For battery start, the left engine should be started first as the static inverter supplies ac power to the left engine instruments during the start cycle. After one engine has been started and the generator is on the line, the static inverter is automatically disconnected.

[Engine Starting Procedure](#)

Crossbleed start

A crossbleed start capability without external air is provided for starting the right engine after the left engine has been started. Compressed air from the ninth stage of the left engine compressor section is used for initial motoring of the right engine. A crossbleed control valve installed as part of the left engine compressor ducting system is alerted for activation when the left

engine throttle is advanced above 70 % rpm. Actuation of the right engine start button opens the crossbleed control valve, permitting air to flow from the left to the right engine. The right engine ignition circuit is then completed by moving the right throttle from OFF to IDLE position. In order to ensure an adequate flow of air for starting, the left engine should be operating at approximately 95 % rpm. Therefore aircraft should be fixated (ask ground crew for wheel chocks via comms menu The crossbleed control valve closes or power is removed from the valve-open circuit:

- any time the left throttle is below approximately 70% rpm;
- whenever the aircraft is airborne;
- approximately after 40 seconds after the right engine start button has been actuated.

[Crossbleed Start Procedure](#)

Airstart

If the throttle is at OFF, the airstart is accomplished by pushing the engine start button and advancing the throttle to IDLE, the same as for ground starts. If the throttle is in the IDLE to MIL range, alternate airstart is accomplished by advancing the throttle into AB (afterburner) range.

[Airstart Procedure](#)

Engine windmill RPM

If one or both engines fail in flight and there is no engine seizure, the compressor is rotated by ram air. The air is compressed in the engine inlet duct. Engine windmill speed depends on airspeed controlled by the pilot through changing aircraft pitch attitude and operative engine rpm.

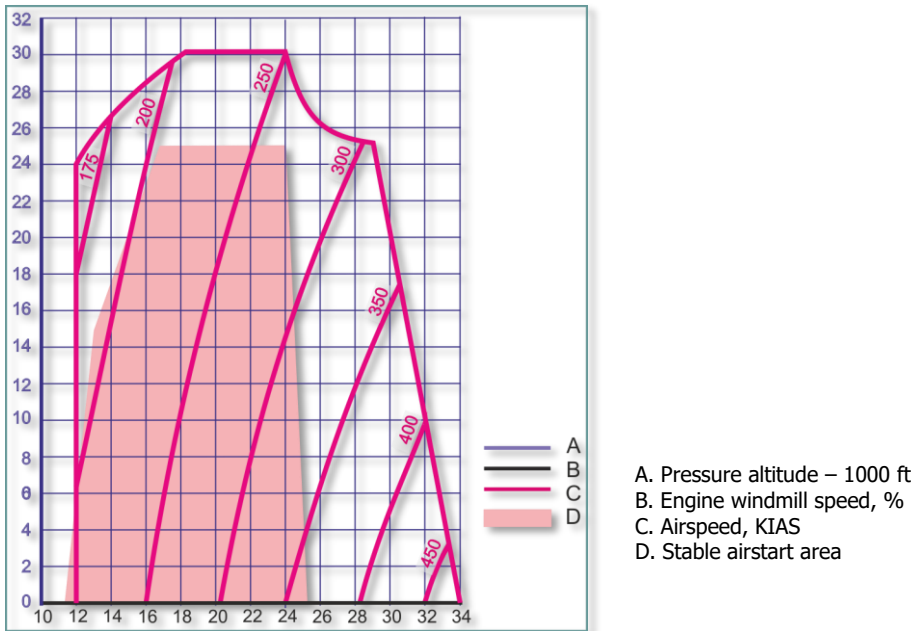

Figure 5.4 Engine Windmill Speed - Pressure Altitude - Airspeed Curve

Note: Airspeeds necessary to achieve engine windmill speed required for successful airstart are indicated in the diagram.

5.6 COMPRESSOR STALL

A compressor stall is an aerodynamic interruption of airflow through the compressor.

The stall sensitivity of an engine is increased by foreign object damage, high angles of attack at low airspeeds and high altitudes, abrupt yaw impulses at low airspeeds (below approximately 150 KIAS), temperature distortion, engine anti-ice system in operation, and ice formation on the engine inlet ducts or inlet guide vanes. Compressor stalls can also be caused by component malfunctions; engine rigged out of limits; throttle bursts to MIL or MAX power at high altitude and low airspeed; hot gas ingestion from other aircraft or during gun firing at high altitudes and negative g conditions; and maneuvering flight with landing gear down at altitudes above 30,000 feet.

Variable inlet guide vanes and variable stators are in the engine to reduce the possibility of compressor stall. Operation is automatic as a function of engine rpm and inlet temperature. A P3 compressor dump system activates for approximately 16 seconds to reduce the possibility of compressor stall when a throttle is burst to AB range at intermediate or high altitudes. This system is simulated in this DCS module. However compressor stall still can be caused by combination of adverse conditions.

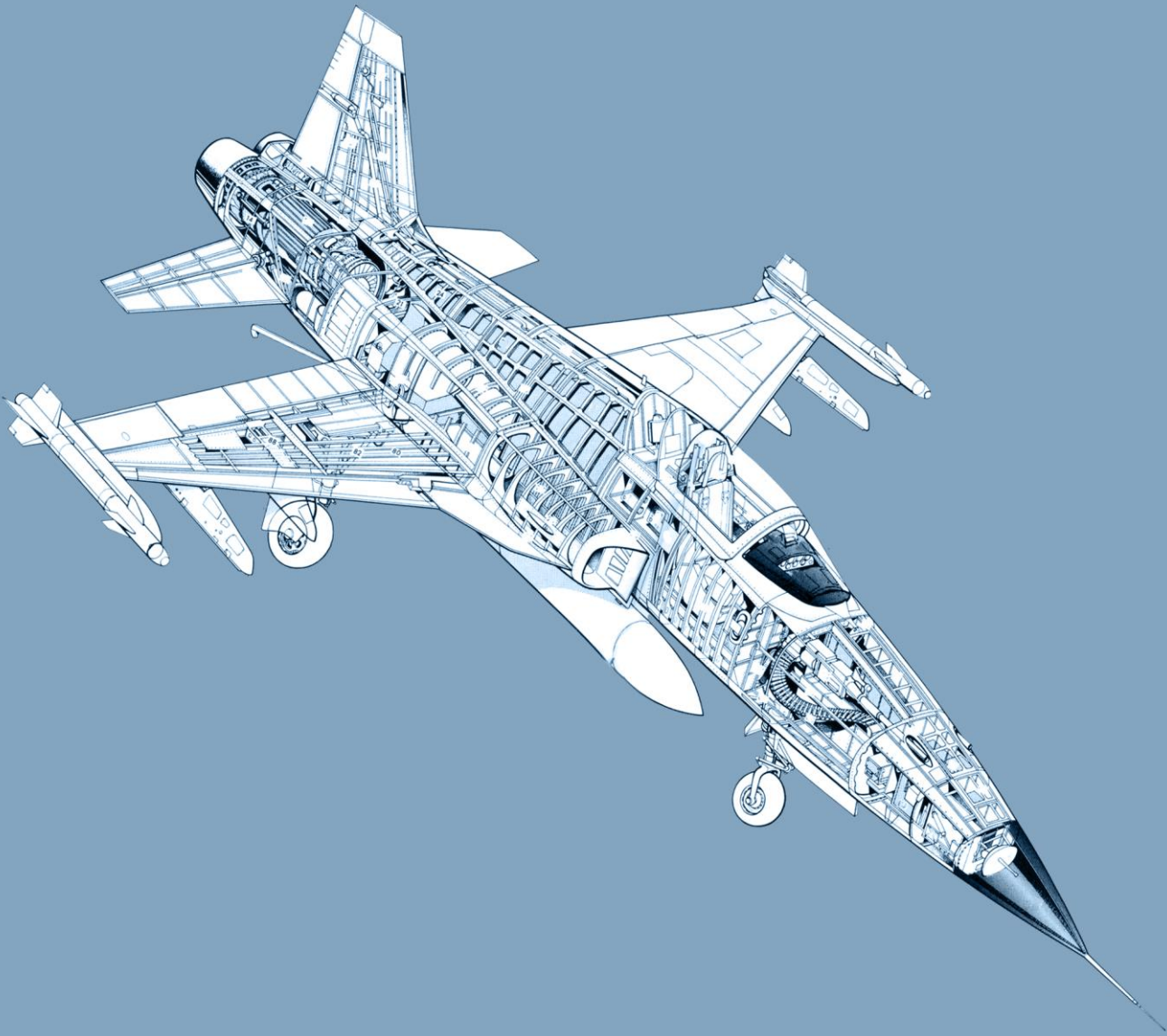

6 AIRCRAFT SYSTEMS

6 AIRCRAFT SYSTEMS

6.1 Fuel System

The fuel system is designed for storing fuel in the aircraft and ensures continuous fuel supply to the engine system along with controlled fuel consumption.

[Fuel System Schematic diagram](#)

The fuel system consists of three fuel cells in the fuselage divided into two independent systems. The forward cell supplies fuel to the left engine; the center and aft cells supply the right engine. If required, either system can supply fuel to both engines. Additionally, jettisonable external tanks may be installed on the aircraft. Fuel is transferred from external tanks to the internal systems thru the single-point manifold by air pressure supplied by the compressor ninth stage of each engine.

Each engine fuel system contains its individual fuel boost pump, fuel shutoff valve, fuel flow indicator, and low fuel and pressure caution lights. A dual pointer fuel quantity indicator on the instrument panel indicates the quantity of remaining fuel in each engine fuel system.

Fuel Boost Pump

Two AC-powered fuel boost pumps provide fuel under pressure to the main fuel pump and afterburner fuel pump in both engines. In inverted flight, the left engine is supplied with fuel from the forward fuel cell and the right engine is supplied from the aft fuel cell.

- Either boost pump is capable of supplying sufficient fuel to both engines throughout the IDLE to MAX power range with the fuel system in crossfeed operation.
- When both fuel pumps are inoperative, the fuel required to maintain maximum afterburner power:
 - flows by gravity at altitudes from sea level to 6000 feet;
 - may flow by gravity at altitudes from sea level to 25,000 feet.

However, it is recommended to reduce power and fly at lowest practical altitude for a given flight conditions to ensure stable engine operation with boost pumps inoperative.

WARNING. With both fuel boost pumps inoperative or off, crossfeed and autobalance are not available.

Fuel Float Switch

Each engine fuel system contains the fuel float switch, which regulates fuel flow when the fuel level drops to less than 350 to 400 pounds depending on AUTO BALANCE switch position. If the float switch closes and fuel level does not increase, the respective engine fuel low caution light comes on and the float switch of the other engine is deactivated.

FOR EXAMPLE, when the AUTO BALANCE switch (switch operation is described below) is at the left low position (left engine fuel system) and fuel level in the right fuel system drops below 350 to 400 pounds (and does not increase within 10 seconds), the float switch in the right system closes and the AUTO BALANCE switch returns to the center position.

6.2 Fuel Quantity Data

Table 6.1 Fuel Quantity Data

FUEL	FULLY SERVICED			USABLE		
	gallons	pounds	kg	gallons	pounds	kg
Both systems (total)	715	4647	2107	694	4511	2046
Left system (forward cell)	313	2034	922	303	1970	893
Right system (2 aft cells)	402	2613	1185	391	2541	1152
275-gallon external tank	275	1788	811	273	1775	805
150-gallon external tank	152	988	448	150	975	442
Maximum fuel quantity with 3 external tanks, 275 gallons each	1540	10010	4540	1513	9834	4460
Maximum fuel quantity with 3 external tanks, 150 gallons each	1171	7611	3452	1144	7436	3373

6.3 Cockpit Controls and Indicators

Fuel balancing between the right and left fuel cells may be controlled either automatically (when the AUTO BALANCE switch (6) is in **LEFT LOW** or **RIGHT LOW** position) or manually (using a **CROSSFEED** switch and by switching off fuel boost pump of the fuel system with a lower fuel quantity).

[Autobalance system operation](#)

[Manual balancing](#)

Fuel transfer from the external tanks to the fuel cells in the fuselage is controlled by means of the respective EXT FUEL (**CL** and **PYLONS**) switches on the right front panel. An **EXT TANKS EMPTY** caution light indicates that external fuel tanks are empty. **EXT TANKS EMPTY** caution light operation depends on the EXT FUEL switch position of the respective fuel tanks, i.e. the light is operative when the respective switch is on.

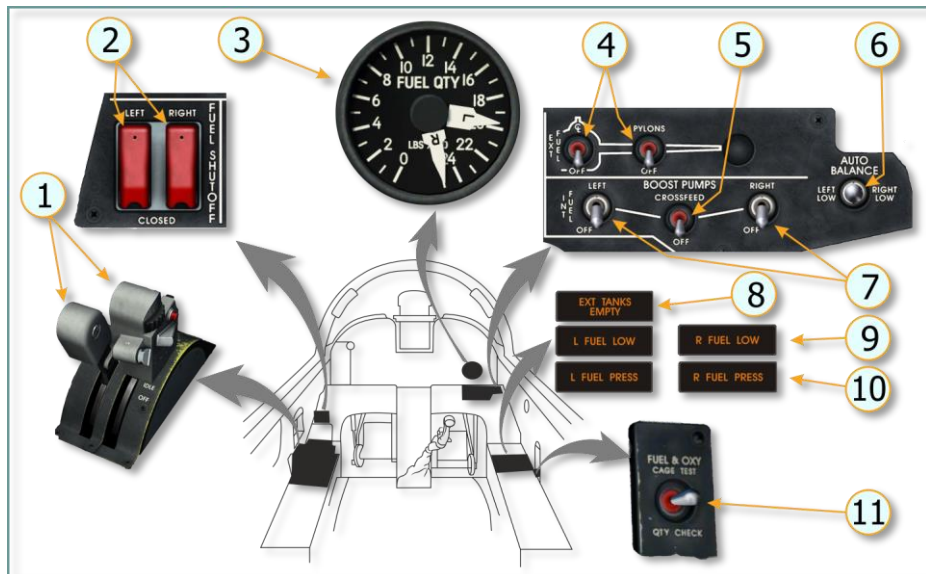

Figure 6.1 Fuel System Controls and Indicators in Cockpit

No.	Element	Function
1.	Throttles (L&R)	OFF - Shuts off fuel by dosing fuel shutoff valve. IDLE - Provides fuel by opening fuel shutoff valve. MIL - Operates engine at military power. MAX - Operates engine at maximum power.
2.	FUEL SHUTOFF Switches (L&R) (Guarded)	Shuts off fuel flow to engine regardless of throttle position. The switch(es) should be used only in an emergency, to prevent fire in case of damages.
3.	FUEL QUANTITY Indicator (L&R Pointers)	Each pointer indicates pounds of usable fuel in respective engine fuel system. Controls autobalance operation to maintain difference in indications within 50 to 125 pounds. AC-operated.
4.	EXT FUEL Transfer Switches.	External fuel tanks switch OFF – Closes fuel shutoff valves in pylons - fuel is not transferred. CL – Fuel is transferred from centerline tank. PYLONS – Fuel is transferred from inboard tanks
5.	CROSSFEED Switch.	OFF – Closes crossfeed valve CROSSFEED – Fuel supply to both engines from one boost pump.
6.	AUTO BALANCE Switch (Spring-loaded to Detented Center Position).	Center (OFF) – Crossfeed valve closed LEFT LOW – Opens crossfeed valve and reverses rotation of left boost pump to provide fuel feeding to right engine. RIGHT LOW – opens crossfeed valve and turns off right boost pump.
7.	BOOST PUMP Switches (L&R).	OFF – Turns off boost pump. LEFT/RIGHT – Turns on respective boost pump.
8.	EXT TANKS EMPTY Caution Light.	Illuminates when fuel transfer from external tanks is complete. Placing EXT FUEL Transfer switch(es) to off position turns light out. Note: If carrying only one inboard fuel tank, the light does not illuminate when external transfer is complete.
9.	L and R FUEL LOW Caution Lights.	Illuminates when fuel remaining in respective system is approximately 350 to 400 pounds or aircraft is placed in negative-G condition for 10 seconds or longer.
10.	L and R FUEL PRESS Caution Lights.	Illuminates when a pressure is 66.5 psi or less.
11.	FUEL & OXY Switch (Spring-loaded to center).	GAGE TEST – Fuel and oxygen quantity indicator pointers rotate counter-clockwise toward zero. (Pointer rotation toward zero is indicative of proper operation of static inverter. Oxygen caution light illuminates when pointer reaches 0.5 liters.) QTY CHECK – total internal fuel and oxygen quantities according to fuel and oxygen quantity indicators. I.e. Momentarily pushing turns instruments to main mode of operation.

6.4 Fuel System Management

Fuel balancing in flight is required because there is a difference in fuel capacity between fuel cells of the right and left engines. Moreover, the engines may use fuel at different rates (for example, when left and right throttles are at different positions). Hence, if fuel quantity in the cells is not controlled, the center of gravity may change, thus affecting flight dynamics

Autobalance Operation

Autobalance operation is initiated by pulling the **AUTO BALANCE** switch out of detent and positioning it to the left or right low position corresponding to the internal system with the lower fuel quantity.



The switch is held in the selected position by a holding solenoid. Selecting either of the positions opens the CROSSFEED valve (the **CROSSFEED** switch shall be placed in down position) and permits feeding both engines from the fuel system with the higher fuel quantity.

FOR EXAMPLE, in the case of substantial difference in fuel quantities (more than 200 pounds, the left engine has less fuel), place AUTO BALANCE switch to the left low position. The CROSSFEED valve opens, rotation of the left boost pump reverses and permits fuel feeding from the right fuel system to both engines.

Autobalance operation ceases when:

- Difference between left and right fuel quantity indicator pointers is within 50 to 125 pounds;
- The low level float switch in the system supplying fuel to both engines closes for longer than 10 seconds;

- CROSSFEED switch is activated (place in the up position).

NOTE: Balancing kicks in after external tanks fuel is depleted and engines start using fuel from internal tanks.

When autobalance operation ceases, the holding solenoid is deenergized, allowing the AUTO BALANCE switch to return to the center position, the CROSSFEED valve closes (unless the CROSSFEED switch has been positioned to CROSSFEED), the low system boost pump resumes normal operation.

NOTE:

- Middle and aft internal tanks have 560 pounds more fuel than forward, therefore AUTO BALANCE should be activated after external tanks fuel is depleted, and right engine fuel usage is maintained;
- Autobalance is operational with one running engine, provided that AC power is available and both boost pumps are operating.

Manual Balancing

Manual crossfeed is accomplished by turning the **CROSSFEED** switch on to open the crossfeed valve and turning off the **BOOST PUMP** switch of the system with the lower fuel quantity.



Turn on the inoperative boost pump as soon as the difference in fuel quantity between the left and right engine is within 100 pounds. After the pump has operated for a minimum of 2 minutes, turn the crossfeed switch OFF.

CAUTION. Failure to fulfill the above procedure (boost pump deactivation) will lead to fuel being used only from one fuel system, causing aircraft unbalance.

Failure to fulfill 2 minutes requirement before placing the CROSSFEED switch in off position may lead to air getting inside fuel system whose boost pump was off, possibly resulting in engine shutdown.

Low Fuel Operation

If an internal fuel system has less than 650 pounds of fuel, the quantity of fuel falls below the fuel boost pump upper-inlet and the boost pump output is reduced approximately 40 %. During crossfeed operation, if the engines are operated at power settings requiring a fuel flow of 6000 pounds per engine per hour or greater, the low pressure light may come on and engine rpm fluctuations may occur because of insufficient fuel pressure.

CAUTION. If both fuel systems below approximately 400 pounds, autobalance operation is not available. Do not attempt to use the CROSSFEED valve, because if the fuel supply in one system is depleted or one of the boost pumps fail, air may be supplied to the fuel line causing dual engine flameout. There is no cockpit indication of boost pump failure.

Single Engine Operation

Autobalance operation should be used until approximately 400 pounds remain in each system. With less than 400 pounds of fuel remaining in each system (800 pounds total), place the CROSSFEED switch to CROSSFEED position to allow the engine to be fed from both systems simultaneously.

External Fuel Sequencing

When external tanks are carried, use inboard tanks first, centerline tank next, and internal fuel last.

NOTE: During ground operation , it is not recommended to transfer fuel from external tanks when fuel quantity in the left fuel system is 1700 pounds or more, or in the right system is 2300 pounds or more.

When inboard tanks are empty (indicated when EXT TANKS EMPTY caution light comes on), check fuel quantity indicator for a decrease in quantity to assure that inboard tanks are empty. To transfer centerline tank fuel, turn off PYLONS fuel transfer switch and turn on CL fuel transfer switch.

NOTE. Failure to turn off the fuel transfer switch when inboard tanks are empty prevents EXT TANKS EMPTY light from indicating when the centerline tank is empty because the EXT TANKS EMPTY light will be permanently on.

6.5 Electrical System

Electrical power is supplied by two ac systems and one dc system. An external receptacle is provided for ac power input to the aircraft when the engines are not in operation. DC power is supplied by a battery and two 33-ampere transformer-rectifiers.

[Electrical System Schematic diagram](#)

AC Power System

AC power is supplied by two 13/15 kva 320 to 480 Hz generators, one operating from each engine. Each generator functions independently and supplies 115/200-volt three-phase power to the ac buses. Normally, power distribution is divided between the right and left systems. One generator automatically assumes the full load, except the corresponding aux intake door, without disruption if the other generator is off or inoperative.

Each engine generator cuts in at approximately 48 % rpm and drops out at less than 43 % rpm.

Two three-position switches placarded L GEN and R GEN are on the right vertical panel, each switch has a RESET position, permitting the pilot to reset the generators if necessary. Generator caution lights, placarded **L GENERATOR** and **R GENERATOR**, on the caution light panel come on any time the respective generator is off.



DC Power System

DC power is obtained from each ac system through a transformer-rectifier which converts AC to DC. A 13-ampere-hour battery serves as a standby source of 24V DC power, and is charged by the transformers- rectifiers.

Static Inverter

A static inverter, connected to DC system, converts 24-volt DC from the battery to 115-volt AC.

During engine start alternate AC power for the following is provided through inverter:

- Engine ignition on the ground and in flight;
- Operation of left engine instruments and utility hydraulic pressure indicator during start of left engine;
- Fuel and oxygen quantity indicators.

On the ground, when the external power source is not available and with power supplied from the battery (battery switch at BATT position), the inverter is activated when either engine start button is pushed or when the FUEL&OXYGEN switch is held at GAGE TEST or QTY CHECK position. During mid-air start the inverter is activated by additionally placing the throttle within the afterburner power range for engine restart.

NOTE: In flight, with electrical system functioning properly, the operation of the static inverter can be checked by positioning the FUEL&OXY switch to GAGE TEST. In this case, fuel and oxygen quantity indicator pointers should start moving counter-clockwise.

6.6 Hydraulic Systems

The aircraft is equipped with two independent hydraulic systems: the utility hydraulic system and the flight control hydraulic system.

[Hydraulic Systems Schematic diagram](#)

The flight control and utility hydraulic systems both provide the hydraulic power for the flight controls.

In addition, the utility hydraulic system provides the hydraulic power to operate:

- Landing gear;

- Gear doors;
- Speed brake;
- Wheel brakes;
- Nosewheel steering;
- Two-position nose gear strut;
- Gun bay purge doors;
- Gun gas deflector doors;
- Yaw and pitch dampers (stability augmenter system).

Each system is powered by a positive displacement piston-type pump. The right airframe-mounted gearbox drives the flight control hydraulic system pump, and the left airframe-mounted gearbox drives the utility hydraulic system pump.

Both systems operate at 3000 psi (pounds per square inch).

Hydraulic Caution Lights

A hydraulic caution light for each system, placarded UTILITY HYD and FLIGHT HYD, on the caution light panel comes on when the respective system pressure drops to 1500 psi or less to indicate a low-pressure condition. The light automatically goes out when a pressure of approximately 1800 psi is restored (i.e. after engine start).

6.7 Landing Gear System

The landing gear system provides:

- Extension and retraction of gear;
- Alternate extension of gear;
- Nose gear strut hike-dehike;
- Nosewheel steering.

The landing gear is extended and retracted by the utility hydraulic system and the process is electrically controlled by the landing gear lever in the cockpit.

NOTE: Gear retraction time is 9 seconds with nose gear strut hiked (3 seconds to dehike the nose strut) and 6 seconds with nose gear strut dehiked (shortened). Gear extension time is approximately 6 seconds.

The main gear is held in the retracted position by individual uplocks hydraulically actuated. The nose gear uplock is contained within the gear dragbrace mechanism. All gears are held down by hydraulic pressure on the gear actuators and locked in the down position by mechanical downlocks.

Position of the gears is indicated by the lights on the landing gear panel. Three green lights come on when all gears are locked in down position.

WARNING. A red warning light and an audible warning signal heard through the headset indicate that the landing gear is in an abnormal position.

Cockpit Controls and Indicators

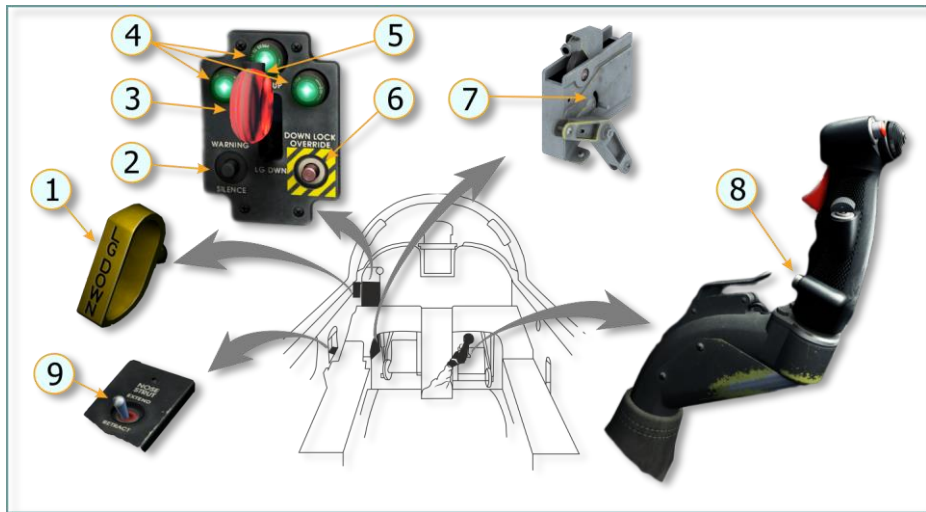

Figure 6.2 Landing Gear Controls and Indicators in Cockpit

No.	Element	Function
1.	Landing Gear Alternate Release D-Handle	When pulled and held (landing gear lever in any position), releases gear uplocks. If handle is not fully in, it may prevent gear normal retraction and extension.

No.	Element	Function
2.	Landing Gear and Flap WARNING SILENCE Button	Momentarily pushing silences audible warning signal.
3.	Landing Gear Lever	LG UP – Retracts landing gear. LG DOWN – Extends landing gear.
4.	Landing Gear Position Indicator Lights (GREEN)	Illumination indicates that landing gear is down and locked with downlocks.
5.	Landing Gear Lever Warning Light (RED).	Illumination indicates that: One or more gears not locked. One or more gear doors open when landing gear is up. With the gear lever up, the red light and audible warning signal activate at altitudes below 9,500 feet, at an airspeed less than 210 ± 10 KIAS, with one or both engines at speed below 96 % rpm. The red light comes on and audible warning signal sounds when the external gear door switch is used to the gear doors (not simulated)
6.	Landing Gear DOWNLOCK OVERRIDE Button.	When pushed and held, permits raising of gear lever by overriding locking solenoid.
7.	Gear Alternate Release Reset Control.	OFF – No function. RESET – Resets landing gear to normal system. CAUTION: When utility hydraulic pressure is recovered, use the reset control to resume normal operation of the gear system after alternate release was applied.
8.	Nosewheel Steering Button.	When depressed and held: On ground – Engages Nosewheel steering, controlled by rudder pedals. In flight – Used as an alternate mic button.
9.	NOSE STRUT Switch.	EXTEND – Lengthens nose gear strut to hiked position. RETRACT – Shortens nose gear to dehike position.

Nose Gear Strut Hike-Dehike System

The nose gear strut can be manually lengthened (hiked) 13 inches (approximately 33 cm) by the pilot using the nose strut switch on the left console (to the left of the throttles).



Nose strut switch ([LAlt + LCtrl + Q])

Full hiking of the strut adds approximately 3 degrees to the aircraft pitch attitude, which shortens takeoff ground run.

NOTE: The nosewheel is steerable in any strut position (hiked or dehiked). However, steering response may be slower during transit.

Automatic strut dehike occurs anytime aircraft weight is off the main gear, regardless of the position of the gear lever.

NOTE: Hiking nose gear strut may cause short-term pressure drop in the utility hydraulic system.

Landing Gear Alternate Extension

Should the normal extension system fail, a landing gear alternate extension shall be used. A landing gear alternate release D-handle is located to the left of the instrument panel.



Landing gear alternate release D-handle
(|LCtrl + LShift + 8|)

Pulling the handle deenergizes the landing gear hydraulic and electrical systems and releases the main gear uplocks, main gear inboard door locks, nose gear, and nose gear forward door to allow the landing gear to extend, assisted by gravity and airloads.

NOTE. 1. When all gears are extended, the gear doors remain open. 2. Nosewheel steering is inoperative after landing.

WARNING. Create a positive-G to ensure reliable locking of landing gear in the down position by the downlocks.

CAUTION. If the handle is improperly stowed, i.e. positioned not fully in, it may prevent gear normal retraction/extension or cause loss of nosewheel steering.

Landing Gear Downlock Override

While the aircraft is on the ground with the struts compressed, the landing gear lever is locked in the LG DOWN position (extended position) and is unlocked after the aircraft lifts off. This locking may be overridden by the pressing and holding DOWN LOCK OVERRIDE button located on the landing gear control panel. Pressing and holding the button allows the lever to be placed at LG UP and retract the landing gear.

Nosewheel Steering System

The nosewheel steering system provides directional control and shimmy damping during ground operation. With the nosewheel steering button

pressed and held, nosewheel steering is controlled by movement of the rudder pedals. Nosewheel steering is available when aircraft weight is on the right main gear. When the nosewheel steering button is released, the system provides viscous shimmy damping capability. Damping is effected by use of hydraulic fluid trapped within the nosewheel steering actuator and is not dependent upon utility hydraulic system pressure.

Wheel Brake System

Each main wheel is equipped with hydraulically operated multiple-disk power brakes. Brakes are operated by conventional toe-type brake pedals (rudder pedals) and use utility hydraulic system pressure to operate brake control valves. Should the utility system fail, the brake valve acts as a brake master cylinder, and brake pressure is proportional to the amount of foot pressure applied to the brake pedal.

6.8 Arresting Hook System

The arresting hook system is an emergency system consisting of a retracted hook under the fuselage aft section and a button to electrically release and extend the hook for runway arrestment. The hook is held in the up position by a lock assembly. The arresting hook is extended by pushing the PUSH button at the bottom of the instrument panel.



Hook release is indicated by illumination of the red light in the PUSH button. If the nose gear strut was hiked, it automatically dehikes after activation of the arresting hook. The hook engagement speed is 160 KIAS.

Note. Hook extends only if landing gear is down.

6.9 Drag Chute System

A 15-foot (approximately 4.5m) deceleration parachute is packed in a container located in the aft fuselage at the base of the rudder.



The chute is deployed by a DRAG CHUTE T-handle located in the cockpit (to the left of the instrument panel) and mechanically connected to drag chute container release mechanism.



Drag chute T-handle



T-handle position at chute deployed



At chute jettisoned

To deploy the chute, the T-handle is pulled by approximately 3 inches (left mouse button click on the handle or press **|P|**). The container opens and the chute is dragged into the airstream. The drag chute is jettisoned by turning the T-handle 90 degrees clockwise and pulling it out by approximately 3 inches more (left mouse button click on the handle or press **|P|**). To stow the handle to its initial position, rotate the handle 90 degrees counterclockwise and push it in (right mouse button click or press **|LShift + P|**)

6.10 Flight Control System

The F-5E flight control system consists of ailerons, horizontal tail, rudder and stability augments system (damping system).

Control surfaces are powered by two independent hydraulic systems. If either hydraulic system malfunctions, the flight control system will remain operative.

The artificial feel is built into the flight control system to simulate feel of high-speed flow action on the control surfaces. The flight control system contains trim actuators that facilitate aircraft piloting and to relieve control pressure from the control stick.

Controls and Indicators

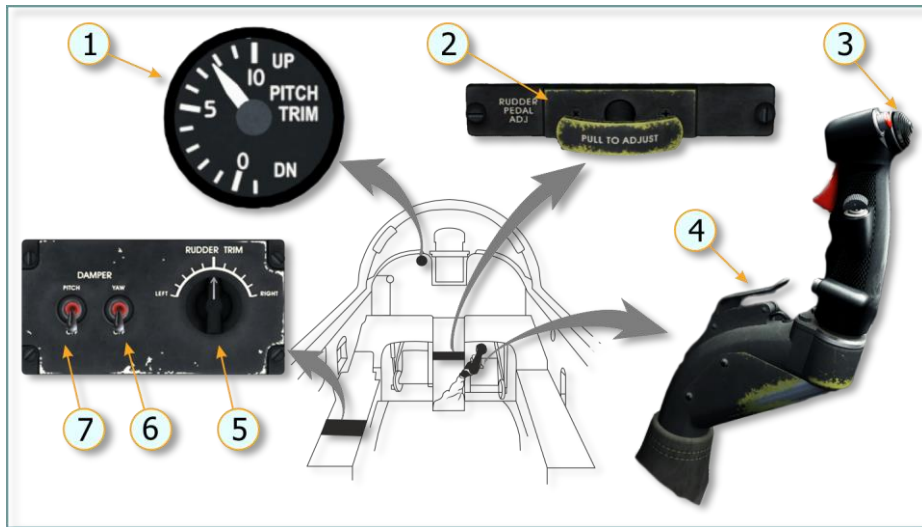

Figure 6.3 Flight Control System Controls and Indicators in Cockpit

No.	Element	Function
1.	PITCH TRIM Indicator	Indicates pitch trim position (control stick position and horizontal tail position, accordingly) from -1 to +10 increments.
2.	Rudder Pedal Adjust T-Handle	Is not used and simulated in game (although may be pulled).
3.	Trim Button	Changes neutral position of control stick by trim actuator. Управляет нейтральным положением ручки управления (триммерным эффектом). Aileron trim: left-right; pitch trim: push (aircraft nose down) 1 increment, pull (aircraft nose up) 10 increments.
4.	Pitch Damper Cutoff Switch	Pressing disengages pitch damper.
5.	RUDDER TRIM Knob	Changes neutral position of rudder pedals (rudder position) 5 increments to the right and left. Trim effective only when yaw damper is engaged.
6.	YAW DAMPER Switch	YAW – Engages yaw damper; OFF – Disengages yaw damper.

No.	Element	Function
7.	PITCH DAMPER Switch	PITCH – Engages pitch damper; OFF – Disengages pitch damper.

Stability Augmenter System (Damping System)

The stability augmenter system (SAS) controls the horizontal tail and rudder to automatically damp out pitch and yaw oscillations and also provides manual rudder trim. I.e. with yaw damper off, rudder trim returns to the neutral position and is inoperative.



The system control panel on the left side includes the pitch and yaw damper switches and the rudder trim knob. The pitch damper cutoff switch is located on the control stick.



The pitch and yaw damper switches are electromagnetically held in engaged positions and springloaded to the off positions. The damping system

disengages and switches return to off positions in case of system malfunctions or loss of AC power.

The CADC controls gear ratio in the dampers during deflection of the control surfaces depending on a signal provided by an airspeed sensor, thus facilitating aircraft piloting throughout the entire aircraft speed range. The system can be disengaged at any time during flight (the aircraft can still be flown safely) and may be reengaged at any time provided system limitations are observed.

Warning:

- Engaging stability augments system should not be attempted at airspeeds above 400 KIAS.
- Engaging stability augments system should not be attempted at altitudes below 5000 feet.
- Engaging stability augments system should not be attempted at load factor other than 1g.

Rudder Travel

Maximum rudder deflection is 30° in each side. The amount of rudder deflection during flight is a function of dynamic pressure force on the rudder surface and varies with airspeed and altitude. Maximum rudder deflection in flight is possible at 250 KIAS or less.

Horizontal Tail Travel

Maximum horizontal tail travel is 17° up and 5° down.

Pitot-Static System

The pitot-static system senses both impact and static air pressure and supplies respective signals to the CADC and the airspeed/Mach indicator. Static pressure is used for altitude and vertical speed indication.

6.11 Wing Flap System

The aircraft is equipped with auto flap system.

Flap system consists of leading and trailing edge flaps used for safe takeoff, inflight maneuvering, long-range flight, and landing.

Each flap is operated by an AC-powered electrical actuator.

The left and right leading edge flaps and the left and right trailing edge flaps are mechanically interconnected to prevent their asynchronous operation, and mechanically interconnected to the horizontal tail to maintain pitch trim during flaps operation.

Flap Controls

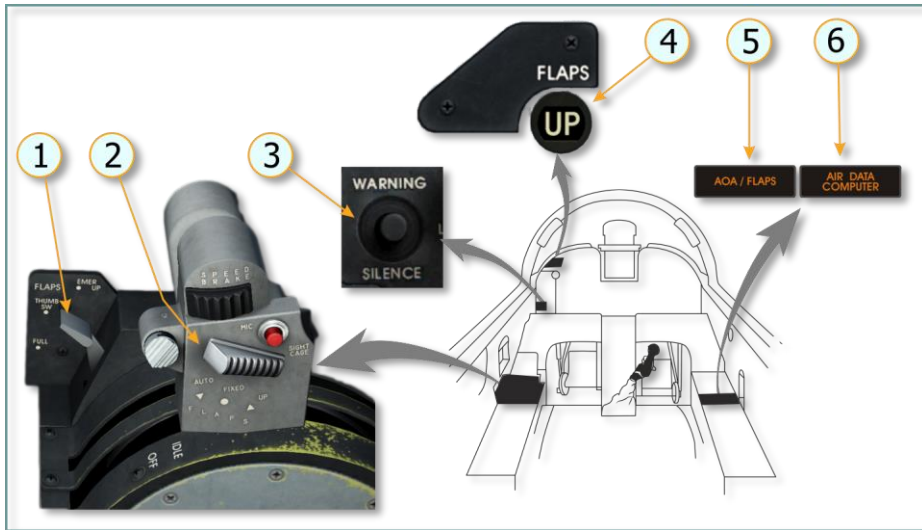

Figure 6.4 Flap system controls and indicator

No.	Element	Function
1.	Flap Lever	EMER UP – Flaps fully retract, overriding the flap thumb switch. THUMB SW – Transfers flap control to flap thumb switch.

No.	Element	Function
		FULL – Flaps fully extended, overriding the flap thumb switch.
2.	Flap Thumb Switch	<p>UP – flaps fully retract (0°/0°). Ensures maximum flying range for all store configurations.</p> <p>FXD (fixed) – flaps in fixed position. Ensures minimum fuel consumption and increases wing lifting efficiency (excludes wing stalling) when flying at reduced speed for maximum endurance with stores loaded.</p> <p>AUTO (automatic) – Enables automatic operation of flaps as a function of AOA and or signals from the CADC.</p>
3.	WARNING SILENCE Button	Pushing silences audible warning signal.
4.	Flap Position Indicator	Ref. Flap Position Indicator
5.	AOA/FLAPS Caution Light	Illumination indicates AOA switching unit failure.
6.	AIR DATA COMPUTER Caution Light	Illumination indicates CADC failure.

FXD Flaps

In fixed flaps setting, flaps are automatically positioned by the CADC:

- 12°/8° position – when flying at altitudes below 32,000 feet above sea level;
- 0°/8° position – when climbing through 32,000 feet (± 2000 feet);
- 12°/8° position – when descending through 28000 feet (± 2000 feet);
- 0°/0° position – when approaching 550 KIAS or 0.95 IMN, regardless of altitude.

If flaps fail to retract, an audible warning signal sounds. The audible warning is silenced by retracting the flaps or pushing the warning silence button located next to the gear lever.

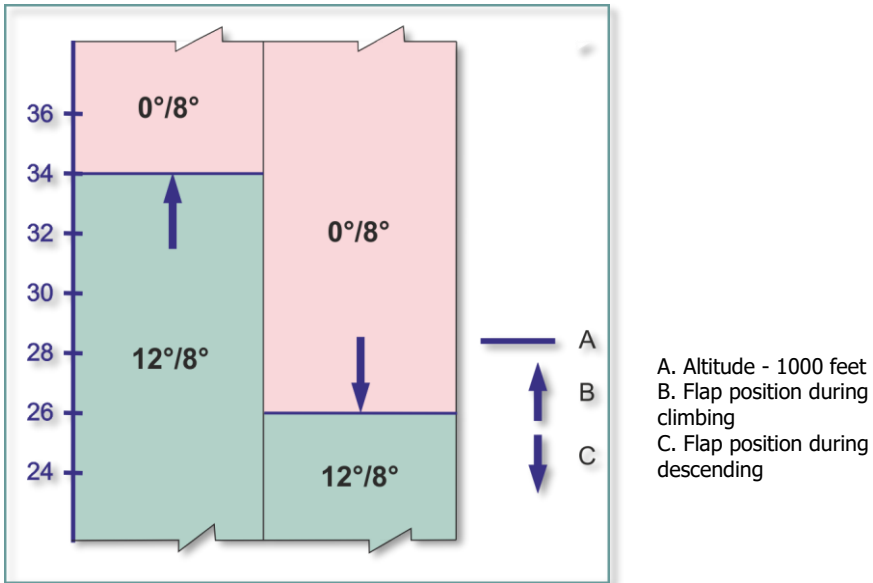

Figure 6.5 Fixed Flap Shift Schedule

AUTO Flaps

With AUTO selected, flaps are automatically positioned depending on AOA and/or signals from the CADC. The flaps can be positioned to $0^{\circ}/0^{\circ}$, $12^{\circ}/8^{\circ}$, $18^{\circ}/16^{\circ}$ or $24^{\circ}/20^{\circ}$. Above 550 KIAS or 0.95 M, the CADC prevents extension of the flaps regardless of AOA and an audible warning signal will sound if the flaps remain extended approaching this speed.

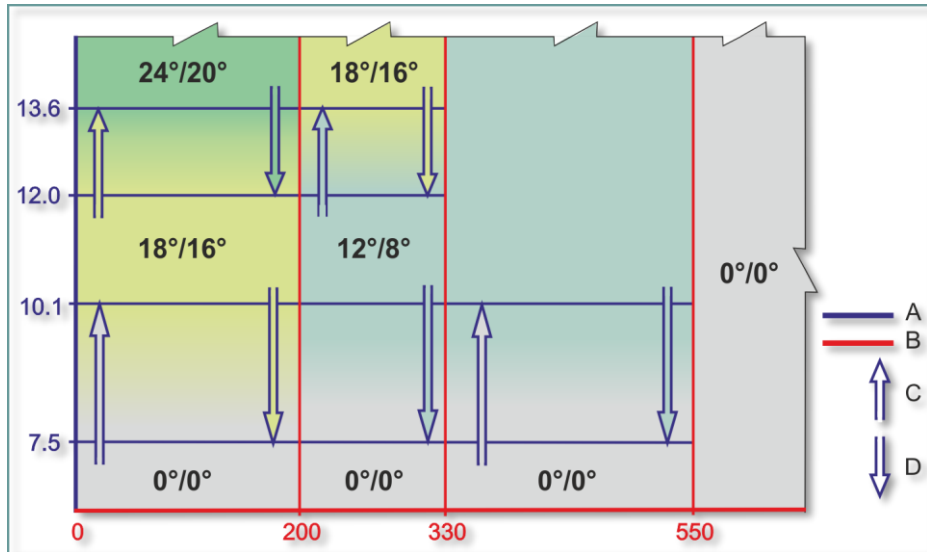

Figure 6.6 Auto Flap Shift Schedule

- | | |
|-------------------------------------|-------------------|
| A. Indicated angle-of-attack, units | C. Increasing AOA |
| B. Indicated airspeed, KIAS | D. Decreasing AOA |

The flap thumb switch set to AUTO:

- 0/0 position – when flying with AOA up to 7.5° at any airspeed within operating range, during increase in AOA from 7.5 to 10.1°, and at airspeeds above 550 KIAS or 0.95 M;
- 18°/16° position – when flying at 7.5 to 12° AOA and during increase in AOA from 12° to 13.6° at airspeeds below 330 KIAS;
- 24°/20° position – when flying at more than 12° AOA at airspeeds below 330 KIAS;
- 18°/16° position – during decrease in AOA from maximum to 12° at airspeeds below 330 KIAS;
- 12°/8° position – when flying at AOA above 10.1° at airspeeds within 330 to 550 KIAS and during decrease in AOA from 10.1° to 7.5° at airspeeds below 550 KIAS;
- Flaps fully extend to 24°/20° position when landing gear is in down position regardless of airspeed.

Flap position should be checked against the flap indicator and warning signal in the cockpit.

6.12 Angle-of-Attack System

The angle-of-attack (AOA) system consists of a vane transmitter mounted on the right side of the fuselage, an AOA indicator and indexer in the cockpit. The system provides AOA information to auto flap system (controls flap position in AUTO setting) and to the CADC for use by the optical sight system.

With landing gear up, the AOA information is displayed only on the AOA indicator. With landing gear down, the system automatically provides AOA information through the AOA indexer.

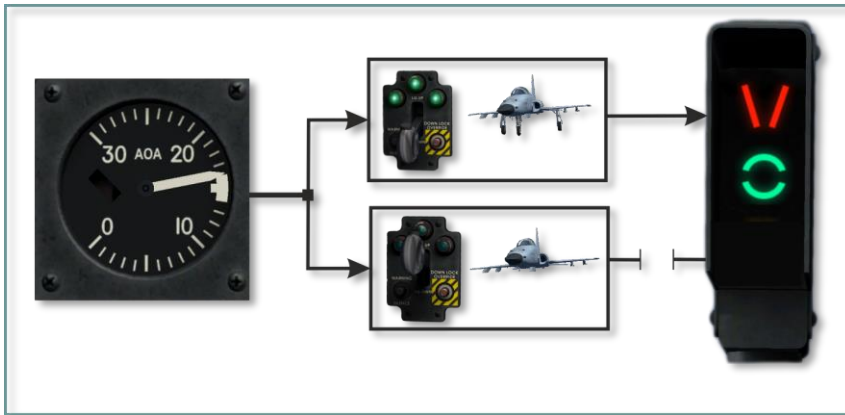

Figure 6.7 AOA Indexer Functioning Conditions

AOA Indicator

The AOA indicator is calibrated in units from 0 to 30. The on-speed index on the indicator dial is the optimum AOA for landing approaches and is set to 15.8 units. With gear and flaps down, the green symbol illuminates on the AOA indexer when the indicator shows 15.8 units. When electrical power is removed from the AOA system, an OFF flag appears on the face of the AOA indicator.

AOA Indexer

AOA indexer is installed to the left of the optical sight reflector and informs the pilot about required approach speed for a certain angle-of-attack. To facilitate perception of the information by the pilot, the lighted symbols on the indexer have three different colors. The slower the airspeed, the bigger AOA is required to maintain given flight conditions.

A red (upper) symbol indicates that AOA is very high, i.e. the aircraft loses speed (stall hazard). A green (center) symbol indicates that AOA is optimum and the aircraft is at the required speed. A yellow (bottom) symbol indicates that AOA is very low for normal landing approach and airspeed is fast. This is not dangerous in terms of stall possibility, but it makes it difficult to perform normal landing.

Angle-of-Attack Displays Operation

Table 6.2 AOA Indexer Operation

			Slow
			Slightly slow
			On-speed
			Slightly fast



AOA Switching Unit

The AOA switching unit provides AOA data to the auto flap control when the AUTO mode is set. An AOA/FLAPS caution light on the caution light panel indicates failure of the AOA switching unit. The AOA indicator and indexer lights operate independently of the switching unit.

6.13 Warning, Caution, and Indicator Lights System

The system warns the pilot about failures critical to flight, hazardous or potentially hazardous conditions, or about a change in system status requiring awareness and possible action by the pilot.

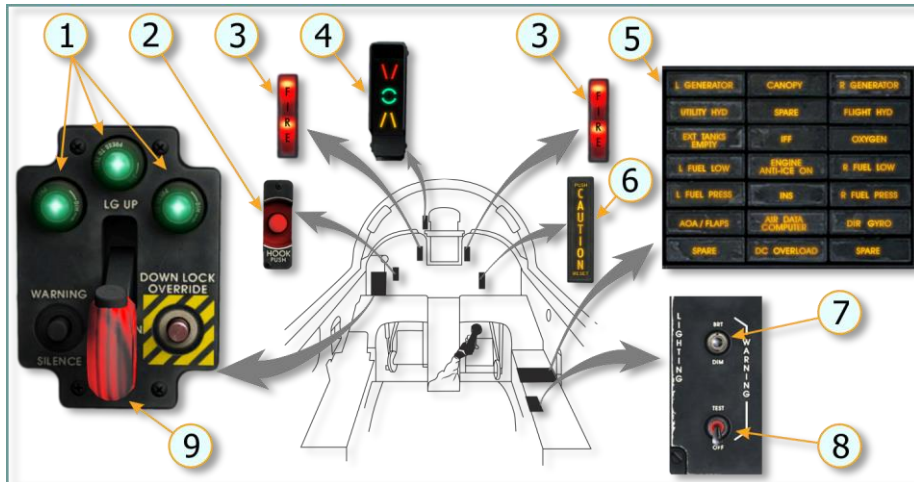

Figure 6.8 Warning, Caution, and Indicator Lights Arrangement in Cockpit

No.	Element	Function
1.	Landing Gear Position Indicator Lights	Illumination indicates each respective landing gear is down and locked.

No.	Element	Function
2.	HOOK PUSH Button Light	Illuminates when arresting hook is released (after activation of arresting hook button), and if nose gear strut is hiked, it automatically dehikes
3.	FIRE Warning Lights (L&R)	Illuminates in case of fire in left and/or right engine compartment.
4.	Angle-of-Attack Indexer Lights	Operate when gear is down and is used during landing approach. Yellow – high speed; Green – on-speed; Red – low speed.
5.	Caution Light Panel	Indicates system malfunction in the applicable system. (21 yellow caution light capsules for individual aircraft systems) Caution Light Panel
6.	MASTER CAUTION Light	Illuminates when a caution light capsule comes on. Goes out when pressed (reverts to standby mode) or after capsule is off.
7.	BRT/DIM Switch	BRT – Momentarily pushing activates bright mode of warning, caution and indicator lights operation. DIM – Momentarily pushing activates dim mode of warning, caution, and indicator lights operation. (Spring-loaded to center). <i>Note: FIRE warning lights always operate in bright mode.</i>
8.	WARNING TEST Switch	TEST — Tests all warning, caution and indicator lights, audible warning, and angle-of-attack indexer lights. Spring-loaded in OFF position.
9.	Landing Gear Lever Warning Light	Illumination indicates that: One or more gears not locked. One or more gear doors open when landing gear are up. With the gear lever up, the red light and audible warning signal activate at altitudes below 9,500 feet, at an airspeed less than 210 ± 10 KIAS, with one or both engines at speed below 96 % rpm.

Caution Light Panel

No.	Caution Light	Triggering condition	Actions required
1.	AIR DATA COMPUTER	CADC unreliable.	Ref. CADC failure/ Pitot-static system failure.
2.	AOA/FLAPS	AOA switching unit failure	Ref. Auto flap system failure.
3.	CANOPY	Canopy unlocked	Lock the canopy
4.	DC OVERLOAD	DC system overload	Ref. DC system failure.
5.	DIR GYRO	Not enabled	
6.	ENGINE ANTI-ICE ON	Engine anti-ice system is on	Indicator light
7.	EXT TANKS EMPTY	Fuel transfer from external tanks completed	Indicator light
8.	FLIGHT HYD	Flight control hydraulic system pressure drops below 1500 psi or overtemperature of hydraulic fluid.	Ref. flight control hydraulic system failure

No.	Caution Light	Triggering condition	Actions required
9.	IFF	Not simulated	
10.	INS	Not enabled	
11.	L FUEL LOW	Left engine fuel level drops below 400 pounds	Ref. Fuel balancing operation
12.	L FUEL PRESS	Left fuel boost pump delivery pressure is below 66.5 psi	Check that left boost pump is ON, reduce left engine rpm, descend below 25,000 feet, and keep an eye on fuel consumption.
13.	L GENERATOR	Left generator failed or turned off	If generator is off, set switch to ON position. Reset generator.
14.	OXYGEN	Oxygen level is below 0.5 liters or oxygen supply pressure is below 40 psi	Descend below 12,000 feet to avoid hypoxia.
15.	R FUEL LOW	Right engine fuel level drops below 400 pounds.	Ref. Fuel balancing operation.
16.	R FUEL PRESS	Right fuel boost pump delivery pressure is below 66.5 psi.	Check that right boost pump is ON, reduce left engine rpm, descend below 25,000 feet, and keep an eye on fuel consumption.
17	R GENERATOR	Right generator failed or turned off.	If generator is off, set switch to ON position. Reset generator.
18	UTILITY HYD	Utility hydraulic system pressure drops below 1500 psi or overtemperature of hydraulic fluid (overtemperature is not simulated).	Ref. utility hydraulic system failure.

6.14 Jettison System

The external stores jettison system provides selective or salvo jettison of pylon carried stores and selective jettison of wingtip stores (missiles).

The system is powered by the battery or by the 28 V transformer-rectifiers.

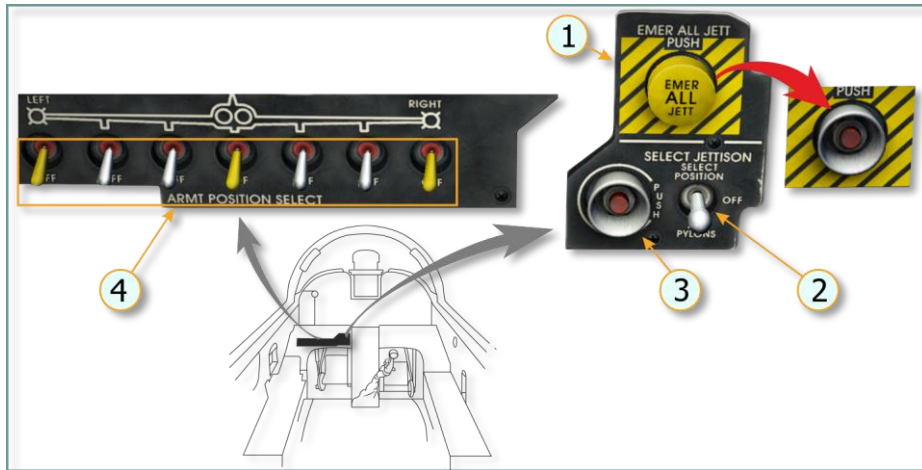

Figure 6.9 Jettison System Controls Arrangement

No.	Element	Function
1.	EMERGENCY ALL JETTISON Button	When pushed – Connects power supply to electrically salvo-jettison stores from all pylons, bypassing all armament control selections. <i>Note. Remove the safety cap before using the button.</i>
2.	SELECT JETTISON Switch	SELECT POSITION – Completes stores jettison electrical circuits to pylons or wingtip launchers selected by armament position selector switch(es). OFF – Disconnects electrical power to select jettison circuits. Note: Switch must be at OFF for normal release/firing circuits to function. ALL PYLONS – Completes pylon jettison circuits to all pylons.
3.	SELECT JETTISON Button	When pushed – Connects aircraft power to electrically jettison selected stores from pylons and wingtip launchers. With select jettison switch at ALL PYLONS , connects aircraft power to electrically jettison stores (if carried) from all pylons followed by jettison of all pylons.
4.	ARMAMENT POSITION SELECTOR Switches	OFF – Opens respective select jettison circuits. UP – Closes respective select jettison circuits.

Select Jettison Switch at All Pylons

When it is necessary to jettison all external stores, the EMERGENCY ALL JETTISON button should be pressed.

Actuation of the button jettisons wing and centerline stores and also actuates the pylon jettison circuits. If pylons are jettisoned with stores, the stores jettison from the pylons first followed by the pylons approximately 1 second later.

Select Jettison Switch at Select Position

The centerline store, any wing store, or paired wing store (both outboard or both inboard) may be jettisoned individually as selected by the armament position selector switches.

It shall be noted that only one release or paired release (both outboard or both inboard) occurs for each actuation of SELECT JETTISON button.

NOTE: After selected store is jettisoned, it must be selected OFF before the next store can be jettisoned.

Sequencing logic provides the following store release priority:

- centerline;
- inboard;
- outboard;
- wingtip missiles emergency launch.

NOTE: For example, in order to jettison the outboard stores, the armament position selector switches of the centerline and inboard stores must be set in OFF position.

6.15 Light Equipment. Exterior Lights

The aircraft is equipped with exterior and interior lights.

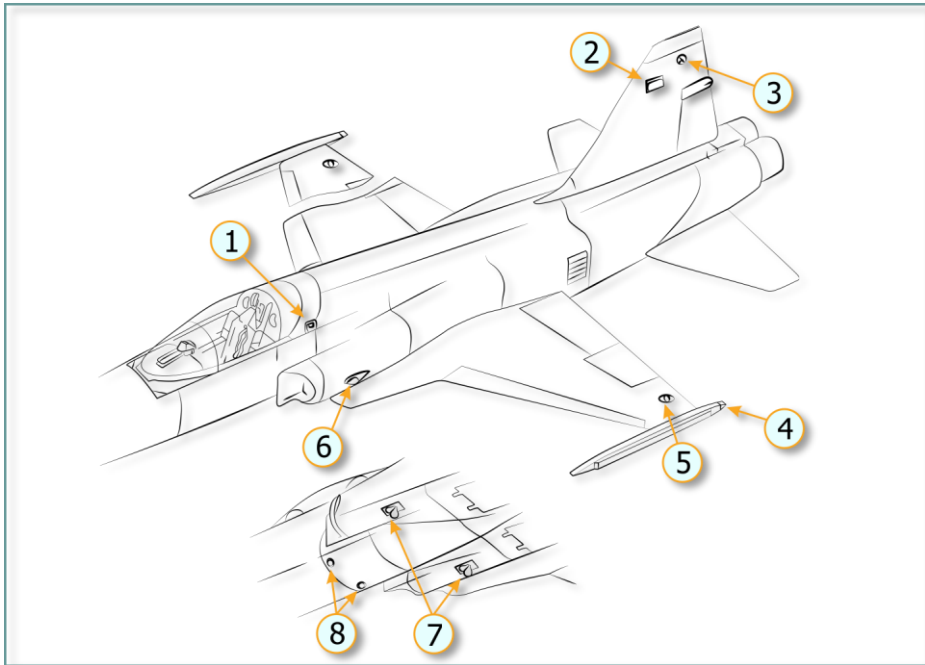
Exterior lights**Figure. Exterior Lights**

1. Formation Light (each side) (white)
2. [Rotating Beacon](#) (each side) (red)
3. Tail Position Light (each side) (white)
4. Formation Light (right green) (left red)
5. Auxiliary Position Light (top & bottom) (right green, left red)
6. Primary Position Light (each side) (right green, left red)
7. [Landing-Taxi Lights](#)
8. Fuselage Lights (white)



Landing-Taxi Lights

Two landing-taxi light are located on the underside of each engine inlet duct.



Light extension and retraction are controlled by an electric motor. In retracted position the lights are inoperative. The lights have two operating positions, a full extension for landing and intermediate for taxiing, and have low and high intensity. The lights are extended during extension of the landing gear after

uplocks opening provided that position light are on and retracted during downlocks opening. The LDG & TAXI LIGHT switch turns on and off the lights.*



LDG & TAXI LIGHT switch turns lights on and off ($[L\text{Ctrl} + L\text{Shift} + Z]$).

In flight, with gear down and LDG & TAXI LIGHT switch on, the lights move to fully open position and are automatically switched to high intensity when the position lights switch is in any position other than OFF. After landing, with weight on the main gear, the lights retract to intermediate position (taxiing mode) and switch to low intensity.

Position and Fuselage Lights

Two position lights are located on each engine inlet duct (6) (right green, left red), four auxiliary position light on the upper and lower surface of each wing and two fuselage light under the fuselage (8). The position and fuselage lights are powered from AC electrical system. The lights are controlled by the NAV knob on a lighting control panel.

Formation Lights

Formation lights are located on each side of the fuselage, a little bit below and behind the cockpit (1), and on the aft end of each wingtip launcher (right

* The lights go on if external light controls in any position other than OFF.

green and left red). The lights are powered by the AC electrical system and controlled by the FORMATION knob on the lighting control panel.

Rotating Beacon

The red rotating beacon (2) is intended to prevent collision during night flight and/or under low visibility conditions and is installed on the vertical stabilizer. The beacon is powered by the AC electrical system and controlled by the BEACON switch on the lighting control panel.

6.16 Interior Lights

All instruments and most of the control panels in the aircraft cockpit are lighted by individual internal lamps.

Flight and Engine Instrument Lights

The instruments on the instrument panel, right vertical panel, and right horizontal console are white-lightened by internal lamps powered by AC system. The lights are controlled by the FLT INSTR and ENG INSTR knobs on the lighting control panel.

Armament Panel Lights

The armament panel lights provide edge lighting of the armament panel and the sight control panel. The lights are powered by the left ac bus and controlled by the ARMT PANEL LIGHTS knob on the left vertical panel. A PNL LT button turns on the sight panel light.

Console Lights

Internal panel lights provide edge lighting of the left and right horizontal consoles, vertical panels and instrument panel. The lights are powered by AC system and controlled by the CONSOLE knob on the lighting control panel.



Figure 6.10 Cockpit illumination



Figure 6.11 Cockpit illumination

Additional (Emergency) Interior Lighting

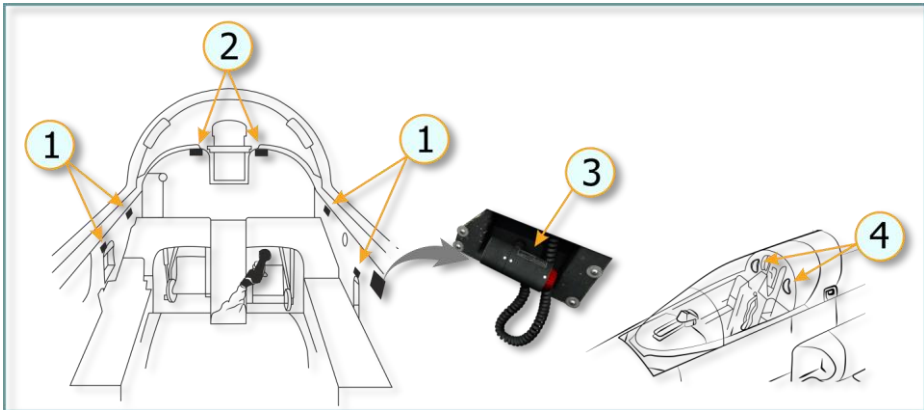

Figure 6.12 Additional Interior Lighting

- | | |
|---|------------------------------|
| 1. Console Floodlights (white) | 3. Utility Light (red/white) |
| 2. Instrument Panel Floodlights (white) | 4. Auxiliary Lights (white) |

White floodlights provide additional illumination of the instrument panel (2) and consoles (1). The floodlights are powered by the AC system and controlled by the FLOOD knob on the lighting control panel.

The utility light (3) powered by battery DC and has switch on its back. In the game, the light can be switched on by pressing |LAlt + L|, light direction is controlled by the mouse*.

NOTE: Floodlights are an emergency lighting. If the AC system fails, the floodlights are powered by the DC system (from the battery) and provide illumination in the cockpit, bypassing the FLOOD knob. In this case, the ENG INSTR knob must be out of the OFF position for the floodlights to operate.



Figure 6.13 Additional (emergency) Interior Lighting

* In game, you have only white light, the model of the utility light is stationary (not animated)

Lighting equipment controls

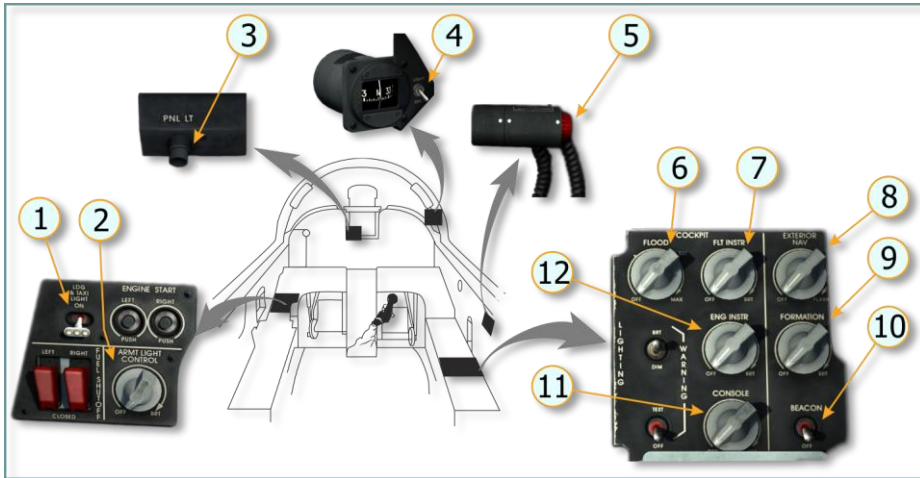

Figure 6.14 Lighting Equipment Controls in Cockpit

No.	Element	Function
1.	LDG & TAXI LIGHT Switch	OFF – Landing-taxi lights off. ON – turns on both landing-taxi lights when gear is down and knob 8 is out of OFF position.
2.	ARMT LIGHT CONTROL Knob	Turns on and controls intensity of edge lighting of armament panel. Note: For button 3 should be used to turn on sight control panel lights.
3.	Sight PNL LT Button	Turns on sight control panel lights. Intensity controlled by knob 2.
4.	Magnetic Compass Light Switch	LIGHT – turns on magnetic compass light, when 12 is on.
5.	UTILITY LIGHT Pushbutton	Turns on utility light. In game, can be turned on by pressing [LAlt + L] , light beam direction controlled by mouse.
6.	FLOOD knob	Turns on and controls intensity of floodlights.
7.	FLT INSTR knob	Turns on and controls intensity of flight instruments.
8.	NAV knob	Turns on and controls intensity of exterior position lights.
9.	FORMATION knob	Turns on and controls intensity of formations lights.
10.	BEACON switch	Turns on rotating beacon on vertical stabilizer.
11.	ENG INSTR knob	Turns on and controls engine instrument lights.

6.17 Oxygen System

A 5-liter liquid oxygen system supplies breathing oxygen. An oxygen regulator panel is located on the right console. An oxygen quantity indicator is located just above the oxygen regulator panel. An OXYGEN caution light of the caution light panel illuminates when liquid oxygen level is below 0.5 liters or supply pressure is below 40 psi).

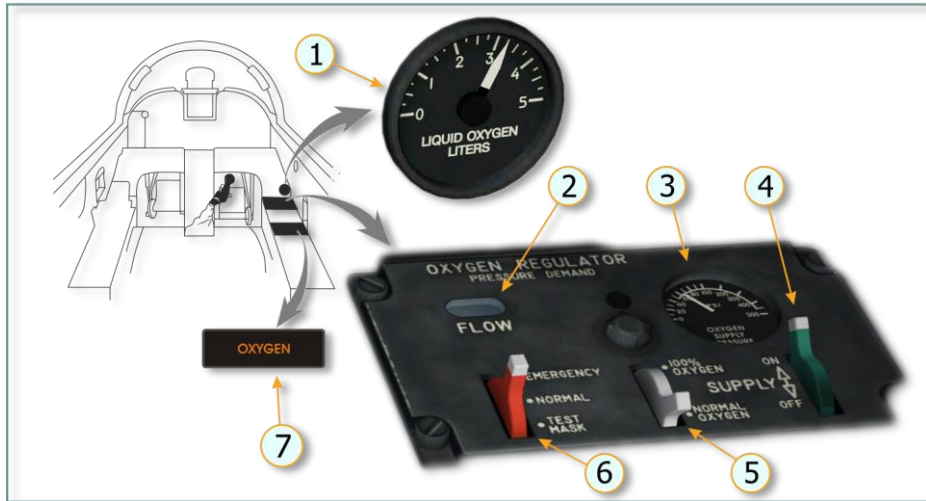

Figure. Oxygen System Controls and Indicator in Cockpit

No.	Element	Function
1.	Oxygen Level Indicator	Indicates oxygen supply from 0 to 5 liters. The indicator is ac powered
2.	FLOW Indicator	Inhale and exhale by the pilot corresponds to black and white background, respectively.
3.	Supply Pressure Indicator	Indicates oxygen pressure in breathing system from 65 to 110 psi.
4.	ON-OFF Supply Lever	OFF – Shuts off all air-oxygen to mask. ON – Turns on air-oxygen to mask.
5.	Diluter Lever	100 % OXYGEN – Provides pure oxygen flow to mask. NORMAL OXYGEN – Provides air-oxygen mixture flow to mask.
6.	Emergency Lever	EMERGENCY – Provides pure oxygen flow to mask. NORMAL - Provides air-oxygen mixture flow to mask. TEST MARK - Provides increased pressure air-oxygen flow to test mask.

No.	Element	Function
7.	OXYGEN Caution Light	Illuminates when liquid oxygen level in bottle is below 0.5 liters or supply pressure is below 40 psi.

Liquid oxygen from oxygen tank flows through pipelines, where it turns into gas state. Gaseous oxygen is supplied to the regulator in the range of 65 to 110 psi. The regulator reduces oxygen pressure and mixes it with air depending on flight altitude.

At high altitude, the regulator supplies positive pressure breathing to ensure vital functions of the pilot. An emergency lever should remain at NORMAL during normal operation of the system.

6.18 Environmental Control System

[Environmental Control System Schematic diagram](#)

The environmental control system consists of:

- Air-conditioning system;
- Pressurization system;
- Canopy and windshield defog;
- Anti-g system;
- Air distribution systems:
 - Canopy seal system;
 - Hydraulic reservoirs pressurization;
 - External fuel tanks pressurization;
 - Waveguide pressurization.

The air-conditioning, canopy pressurization, and canopy seal systems are controlled by controls on the right vertical panel. All other systems are controlled automatically.



Figure 6.15 Environmental Control System Controls and Indicators in Cockpit

No.	Element	Function
1.	CANOPY DEFOG Knob	OFF – Shuts off the windshield and canopy defog air. INCREASE – Activates system to control amount of airflow to the windshield and canopy for defogging purposes.
2.	CABIN PRESS Switch (Guarded)	RAM DUMP – Allows ram air to enter cockpit for ventilation. NORMAL – Activates system to pressurize and air-condition cockpit. In this position, the guard is closed.

No.	Element	Function
		DEFOG ONLY – Deactivates automatic defog control in cockpit. Only canopy and windshield defog system is operating.
3.	CABIN TEMP Switch	AUTO – Automatically maintains cockpit temperature selected by CABIN TEMP knob. Center (Neutral) – Deenergises temperature control valve (remains position held at time switch was moved in neutral). MAN COLD – Temperature control valve closes hot air supply. (cockpit cooling). MAN HOT – Temperature control valve closes cold air supply. (cockpit heating).
4.	CABIN TEMP Knob	Selection cockpit temperature for automatic control.
5.	PITOT Heat Switch	Turns on pitot boom heating.
6.	ENGINE Anti-Ice Switch	Turns on hot air supply to the engine inlet guide vanes.
7.	Cabin Pressure Altimeter	Indicates pressure altitude in cockpit. If cockpit pressure altitude differs from altitude indicated by altimeter, cockpit is pressurized.
8.	Cockpit Air Inlet	Ensures air supply into pressurized cockpit.
9.	Altimeter	Indicates flight altitude. Warning: In case of loss of cabin pressurization (for example, due to combat damages), descend below 10,000 feet to ensure vital functioning of the pilot.

Air from the ninth stage of the compressor section of each engine is used to perform cooling, heating, conditioning, and pressurization functions. Either engine provides sufficient air to operate the system in the event of engine failure.

With the increase in flight altitude, the pressurization system maintains pressure suitable for human according to pressurization schedule.

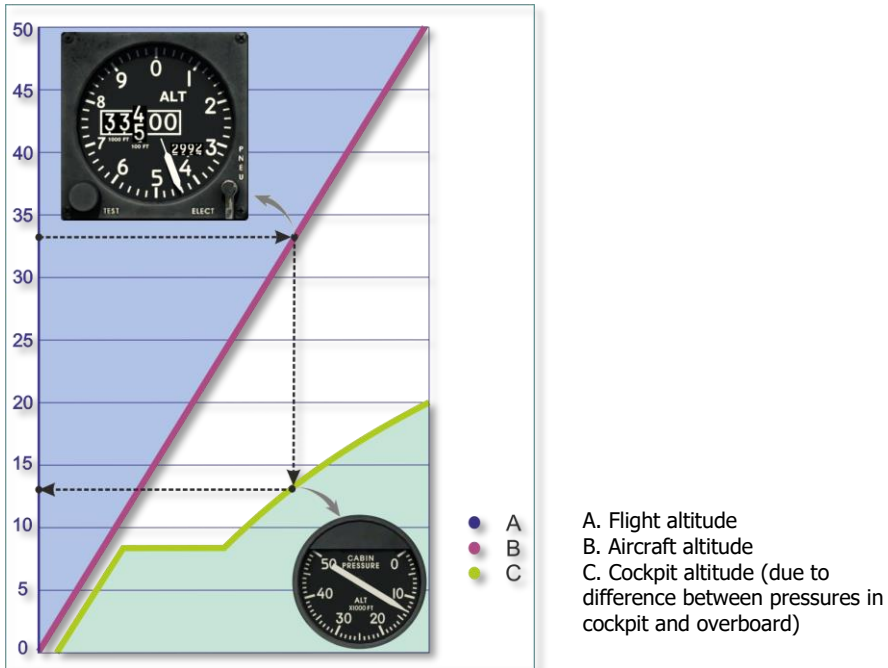

Figure 6.16 Cockpit Pressurization Schedule.

Readings of cockpit instruments at 33,440 feet altitude shown on the figure are given as an example. In pressurized cockpit pressure at 33,440 feet approximately corresponds to 13,000 feet altitude.

6.19 Communication Equipment

The F-5E aircraft is equipped with the AN/ARC-164 UHF radio, AN/ARA-50 UHF/ADF automatic direction finder, and AN/AIC-18 intercommunications system.

Antenna Locations

Antennas are located at the bottom of the fuselage and on the vertical stabilizer. Some antennas are under the aircraft skin. For this reason, the figure below shows only places where they are located.



Figure 6.17 Aircraft Antennas Arrangement

- | | |
|-------------|----------|
| 1. TACAN | 4. UHF |
| 2. UHF/ IFF | 5. TACAN |
| 3. UHF/ADF | 6. IFF |

Communications Controls Arrangement in Cockpit

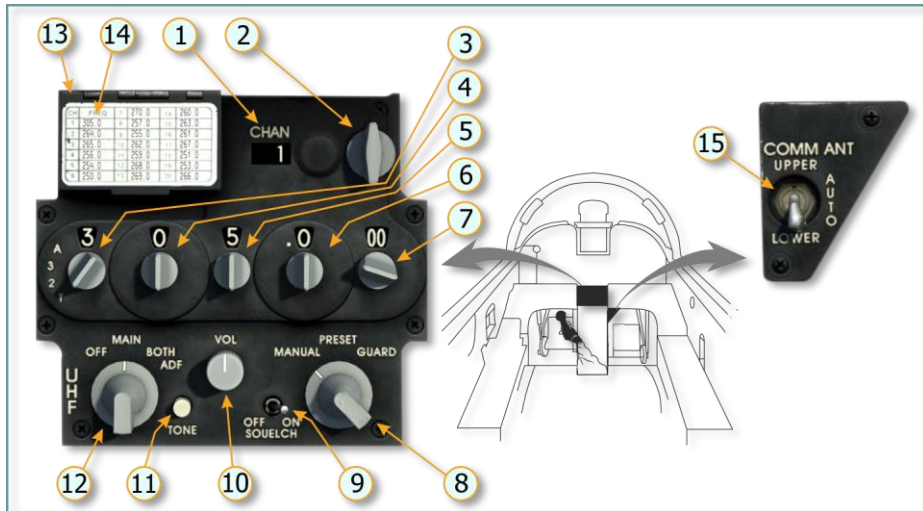

Figure. Communications Controls

No.	Element	Function
1.	Preset Channel Indicator	Displays preset UHF channel selected with preset channel selector control.

No.	Element	Function
2.	Preset channel selector control	Selects one of 20 preset UHF channels.
3.	100 MHz frequency selector knob	Turning this knob changes frequency in 100 MHz increments. Can be set to 4 positions: T, 2, 3 and A.
4.	10 MHz frequency selector knob	Turning this knob changes frequency in 10 MHz increments. Can be set to positions from 0 to 9.
5.	1 MHz frequency selector knob	Turning this knob changes frequency in 1 MHz increments. Can be set to positions from 0 to 9.
6.	0.1 MHz frequency selector knob	Turning this knob changes frequency in 0.1 MHz increments. Can set to positions from 0 to 75 in 25 increments.
7.	0.25 MHz frequency selector knob	Turning this knob changes frequency in 0.025 MHz increments. Can set to positions from 0 to 75 in 25 increments.
8.	Frequency Selector Mode Control	Selects method of frequency selection indicated in frequency display. MANUAL Frequency is manually selected by setting of the frequency selector knobs. PRESET Permits selection of one of preset frequencies by means of preset channel selector control. GUARD (EMERGENCY MODE). In emergency mode, automatically selects emergency frequency and displays it on frequency display.
9.	SQUELCH Control Switch	ON Eliminates background noise in UHF normal reception. OFF Disables squelch to permit reception of a weak UHF signal.
10.	Volume Control	Controls volum of UHF reception.
11.	TONE Transmit Button	When pushed and held, transmits a 1020 cps tone of the selected frequency.
12.	Function Selector	Sets operating mode of radio. OFF Turn power off. MAIN UHF radio operates as transceiver, i.e. you can listen to selected channel and simultaneously transmit voice information. BOTH UHF radio monitors emergency channel and operates as transceiver. ADF Relative bearing to tuned station is displayed.
13.	Hinged Access Door for Present Channel Set Switch	Must be raised for access to yellow LOAD button. In order to load frequency in the preset channel, select frequency manually, select preset channel for which the frequency should be assigned and push the button.
14.	Preset Channel Chart	Present channel frequencies are indicated in appropriate spaces.

No.	Element	Function
15	Antenna Selector Switch (COMM ANT)	Selects required antenna. UPPER – selects upper UHF antenna in aircraft vertical stabilizer. AUTO – Automatically selects upper or lower antenna. LOWER – Selects lower antenna.

The AN/ARC-164 UHF radio provides air-to-air and air-to-ground communication.

Twenty frequencies may be preset and selected by the preset channel selector switch. In addition, channel frequency may be selected using the manual frequency selector knobs.

Frequency range is 225.000 to 399.975 MHz.

The ARA-50 ADF operates in conjunction with the radio to provide bearing indication to any ground or airborne UHF station to which the radio is tuned. Any frequency in the standard UHF communications band may be used. Relative bearing information is displayed on the HSI when the ADF position is selected on the radio control panel.

The NAV MODE selector must be set to DF position on the TACAN AN/ARC(N)-118 panel to display relative bearing information of the HIS.

6.20 TACAN AN/ARC(N)-118 Navigation System

The Tactical Air Navigation (TACAN) system is a global network of omnidirectional beacons with unique frequency codes and is primarily used by military aircraft. Civil aircraft use similar system named VOR (VHF omnidirectional range), which operates in other frequency range. Many VOR stations are combined with a TACAN. Such stations simultaneously transmit two signals and can be used both by civil and military aircraft. These stations are called VORTACs.

The TACAN system is used to quickly determine coordinates of a specific place, usually, it is an aerodrome.

The TACAN provides the pilot with bearing and distance to a selected TACAN ground station. The TACAN system is often used to quickly get navigational data of friendly aerodromes. Moreover, some aircraft are capable of transmitting signals of a TACAN beacon.

TACAN AN/ARC(N)-118 Controls Arrangement in Cockpit

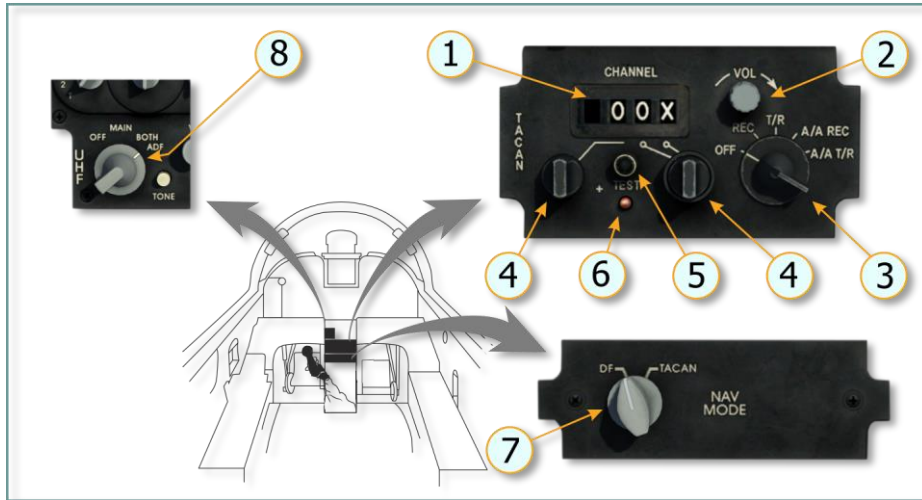
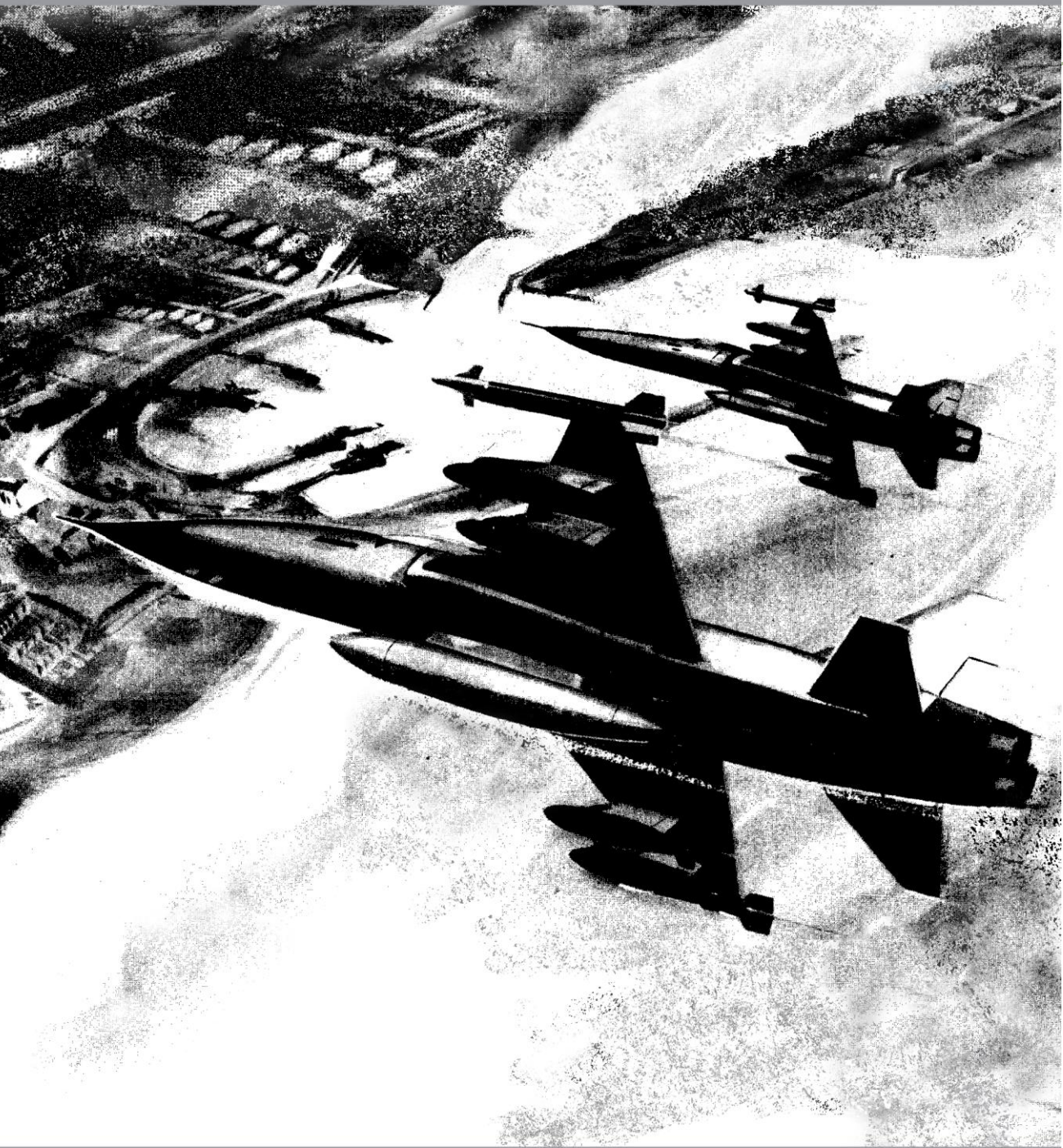

Figure 6.18 TACAN AN/ARC(N)-118 Controls in Cockpit

No.	Element	Function
1.	CHANNEL Display Window	Displays selected channel.
2.	Volume Control	Controls volume of identification signals of selected TACAN channel.
3.	Function Selector	<p>OFF – Turns off power of TACAN system.</p> <p>REC – Receiving identification signals from selected station and provides bearing to station.</p> <p>T/R – Transmitting and receiving. Provides bearing and range to station.</p> <p>A/A REC – Receiving identification signals and bearing information fro specially equipped cooperating aircraft.</p> <p>A/A T/R – Provides range to cooperating aircraft and bearing and range to specially equipped cooperating aircraft.</p> <p>Note: The air-to-air mode provides range to similarly-equipped cooperating aircraft out to 250 nm. Cooperating aircraft must select TACAN channels spaced 63 channels apart.</p>
4.	Channel Selector Controls	Two knobs are used to control digits from 0 to 9, in this case, two-digit value corresponds to identification signal of TACAN channel.
5.	Test Light	<p>Blink – Channel in test mode.</p> <p>On – Channel has malfunctioned (has not passed the test).</p>

No.	Element	Function
6.	TEST Pushbutton	<p>Tests TACAN information displayed on the horizontal situation indicator (HSI). Function selector switch should be at T/R, any channel should be selected and course set to 180 degrees. TEST light blinks; Range warning flag and OFF flag appear on HIS.; Bearing pointer slews to 270 degrees for 7 seconds; Range warning flag and OFF flag disappear; Range warning flag and OFF flag disappear; Range window shows 000, bearing pointer slews to 180 degrees, CDI cents, and TO indication appears for 15 seconds; Range warning flag and OFF flag reappear.</p>
7	NAV MODE Selector	<p>This knob allows choosing pointer indication on HIS. TACAN – HIS pointer will indicate bearing to TACAN station. DF – HIS pointer points to UHF station selected on UHF ARC-164 radio with radio function selector in MAIN or BOTH.</p>
8.	Radio Function Selector	<p>ADF Relative bearing to tuned station is displayed.</p>



7 WEAPON SYSTEMS

7 WEAPON SYSTEMS

The aircraft contains the following weapon systems:

- Weapon release system
- Weapon suspension system
- Fire control system
- Defensive systems
- Sight camera
- Weapons

7.1 Weapon Release System

The weapon release system contains:

- Normal release system
- Firing system
- Jettison release system

The normal release system provides release of bombs.

The firing system is used for firing guns, missiles, rockets, and flares.

Note: Weapon firing and release circuits are deactivated when the aircraft is on the ground.

The jettison release system provides jettison of stores and pylons on the ground or in flight with the gear up or down.

Weapon release controls

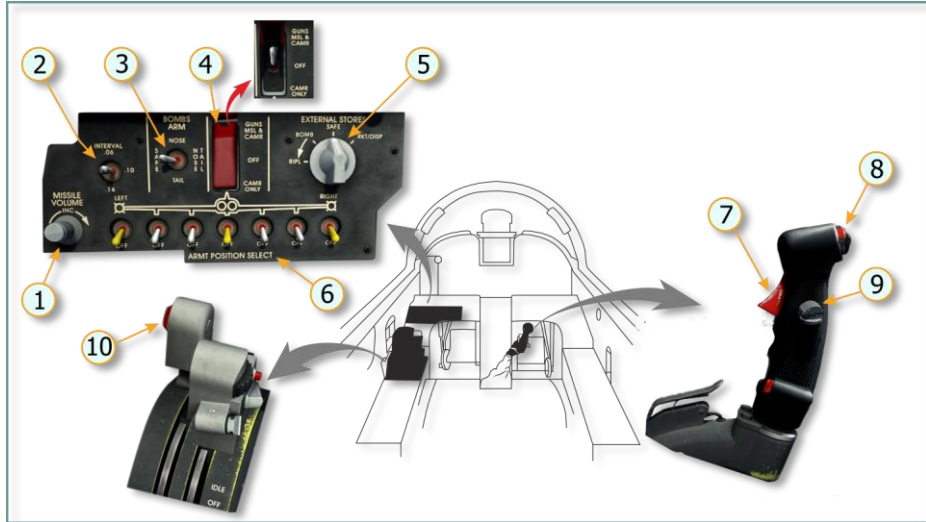
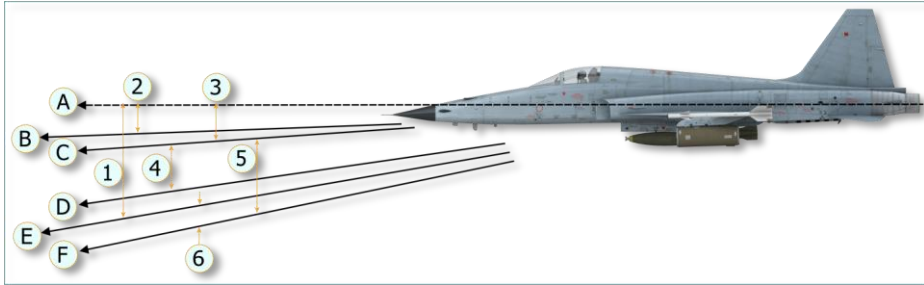

Figure 7.1 Weapon Release Controls in Cockpit

No.	Element	Function
1	AIM-9 Missile Volume Knob	Adjusts volume of audio tone signaling about missile seeker lock-on.
2	Interval Switch	Selects external stores release interval to the selected pylon stations when the external stores selector is in RIPL . Sequence of release is outboard, CL, and then inboard pylons. Intervals are 0.06/0.10/0.14 seconds.
3	Bombs Arm Switch	Selects arming circuits to respective bomb rack solenoids. SAFE – Disconnects electrical power to arming circuits. NOSE – Selects arming circuits to nose and center arming solenoids. NOSE & TAIL – Selects arming circuits to nose, center, and tail arming solenoids. TAIL – Selects arming circuits to tail arming solenoid.

No.	Element	Function
4	Guns/Missile, and Camera Switch	<p>Turns on sight camera and arms guns and wingtip missiles.</p> <p>OFF – Disconnects electrical power to sight camera.</p> <p>GUNS/MSL & CAMR – Arms guns and selects sight camera; whenever trigger or bomb-rocket button is pressed, sight camera automatically records gun fire or missile launch.</p> <p>CMR ONLY – Selects camera circuit only.</p>
5	External Stores Selector	<p>Selects weapons on pylons.</p> <p>SAFE – Disconnects electrical power to all firing/release circuits.</p> <p>BOMB – Connects electrical power to stores release circuitry of selected pylon stations.</p> <p>RIPL – Connects electrical power to stores release interval circuitry of selected pylon stations.</p> <p>RKT/DISP – Connects electrical power to selected pylon rocket launcher or flare dispenser.</p>
6	Armament Position Selector Switches	<p>Selects respective pylons and wingtip launchers.</p> <p>OFF – Disconnects electrical power.</p> <p>UP – Connects electrical power.</p>
7	Trigger	<p>Out of Detent – Trigger is off.</p> <p>First detent – Opens gun gas-purge and deflector doors.</p> <p>Second detent – Fires guns and runs camera.</p> <p>Note: If the trigger is squeezed right to the second detent, firing will start after 0.25 seconds. The delay is caused by opening gas-purge and deflector doors.</p>
8	Bomb-Rocket Button	<p>Activates firing or release circuits for launching missiles, releasing bombs, launching rockets and dispensing flares.</p>
9	Dogfight/Resume Search Switch (Spring-loaded to Center)	<p>Center Position (Momentary Press) – Releases DG and DM modes (if actuated) and reactivates normal release circuitry.</p> <p>Aft Position (Momentary Press) – Selects DG mode and overrides all normal release circuitry.</p> <p>Forward Position (Momentary Press) – Selects DM mode and overrides all normal release circuitry.</p>
10	Missile Uncage Switch (Spring-loaded off)	<p>When pressed, uncages missile seeker head.</p>

Reference Lines**Figure 7.2 Reference Lines**

- | | |
|---|---|
| A. Fuselage Reference Line (FRL) | 1. Angle of Attack |
| B. Wingtip Launcher Line (WLL) | 2. 26 mil (1,5°) |
| C. Armament Reference Line (ARL) (Zero Sight Line, Gun Bore Line, LAU Rocket Launcher Line, Radar Boresight Line – DM mode) | 3. 35 mil (2°) |
| D. Radar Boresight Line (RBL) – A/A1, A/A2, and DG modes | 4. 82 mil (4,7°) |
| E. Velocity Vector, Flight Path | 5. Sight Depression (Guns and Rockets). |
| F. Depressed Sight Line (variable), When Sighting Ground Targets | 6. Sight Depression (Bombs) |

7.2 Jettison System Controls[Jettison System Controls](#)**7.3 Weapon Suspension System**

The aircraft weapon suspension system contains five pylons with MAU-50/A racks.

All pylons are jettisonable.

The centerline and inboard pylons contain the equipment necessary for installation of the external fuel tanks.



Centerline Pylon



Inboard Pylon



Outboard Pylon

The missile launchers (LAU-100/A and LAU-101/A, left and right, respectively) are provided for carrying, powering and firing AIM-9 missiles.

The launchers are installed on the aircraft wingtips.

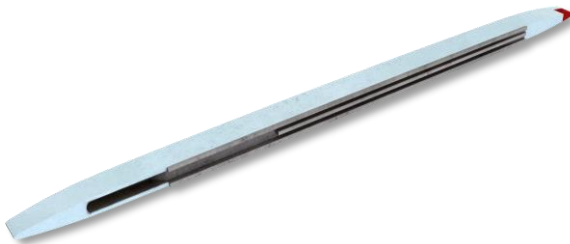

Launcher

When both wingtip launchers are selected, the left missile is fired first and the second actuation of the bomb-rocket button fires the right missile.

7.4 KB-26A Sight Camera

The sight camera provides photorecording of sight picture and target during air-to-air and air-to-ground attacks. The sight camera records target and sight picture at the moment of trigger squeezing and bomb-rocket button activation.

The camera stops running after releasing the trigger or bomb-rocket button.

Camera overrun time can be selected (settings are 0, 3, 10, and 20 seconds). In this case, the camera will continue to run after the trigger or bomb-rocket button is released. Photorecording can be made either on black-and-white or color film. The camera contains a 16mm film magazine with 65-foot capacity. Air targets are recorded at 24/48 frames per second. Ground targets are recorded at 48 frames per second.

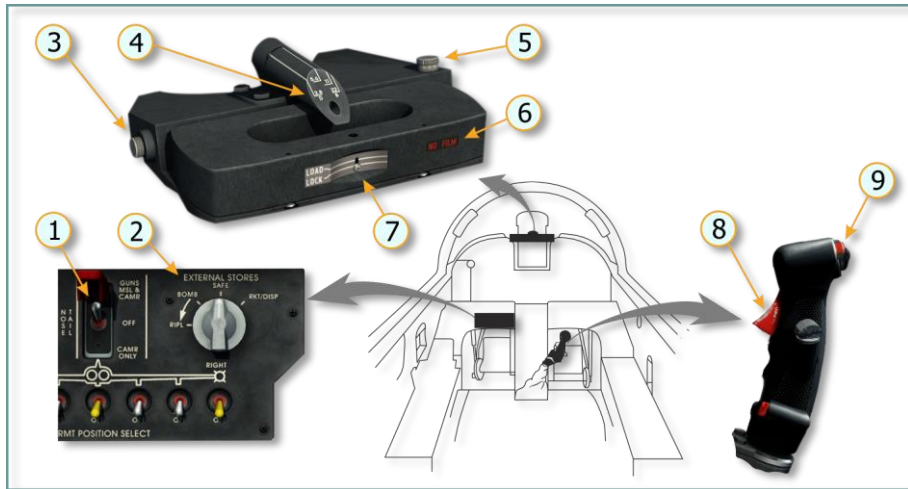

Figure 7.3 Sight Camera Controls in Cockpit

No.	Element	Function
1.	Guns, Missile, and Camera Switch	Turns on sight camera. OFF – Disconnects electrical power to camera. GUNS/MSL & CAMR – Whenever trigger or bomb-rocket button is pressed, sight camera automatically records gun fire or missile launch. CMR ONLY – Selects camera circuitry only.
2.	EXTERNAL STORES Selector	Selects pylons, launchers and camera circuitries. SAFE – Disconnects electrical power to camera.

No.	Element	Function
		<p>BOMB – Selects camera circuitry and connects electrical power to stores release circuitry of selected pylon stations with bombs. Camera runs when bomb-rocket button is pressed.</p> <p>RIPL – Selects camera circuitry and connects electrical power to stores release interval circuitry of selected pylon stations with bombs. Camera runs when bomb-rocket button is pressed.</p> <p>RKT/DISP – Selects camera circuitry and connects electrical power to pylon rocket launcher or flare dispenser circuitry. Camera runs when bomb-rocket button is pressed.</p>
3.	FPS Select Switch	Permits switching to 24 or 48 frames per second
4.	Sight Camera	Records firing
5.	Overrun Selector	Permits selection of film exposure overrun time after the trigger or bomb-rocket button is released. Settings are: 0, 3, 10, and 20 seconds.
6.	FILM/FT Indicator	Indicates feet of film remaining in camera magazine.
7	LOAD/LOCK Button (Spring-loaded to LOCK)	Not implemented.
8.	Trigger	<p>Out of Detent – Camera deactivated.</p> <p>First Detent – Runs camera.</p> <p>Second Detent – Runs camera.</p>
9.	Bomb-Rocket Button (Weapon Release Button)	<p>Pulled position – Camera deactivated.</p> <p>Pressed position – Runs camera.</p>

7.5 Fire Control System

The fire control system assists aiming process and provides the pilot with indications and commands required for weapon employment.

The fire control system consists of:

- AN/APQ-159(V)-3 fire control radar (FCR);
- AN/ASG-31 lead computing optical sight system (LCOSS).

A schematic diagram of the fire control system is shown in Figure

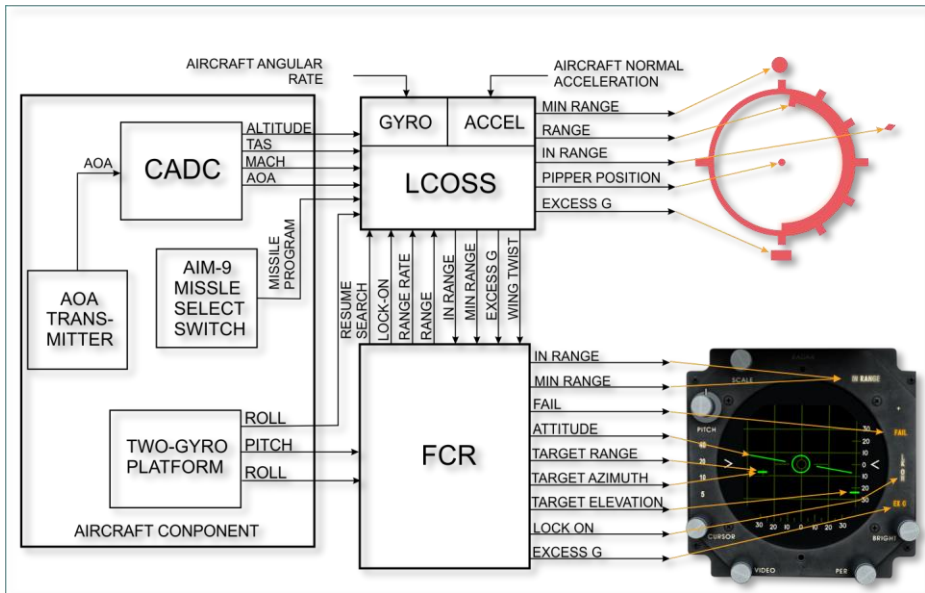

Figure 7.4 Fire Control System

The AN/APQ-159(V)-3 and AN/ASG-31 may operate jointly or separately during air-to-air attacks.

During air-to-ground attacks, only AN/ASG-31 is used. IR seeking missiles and guns are used for air-to-air attacks. Bombs, rockets, and guns are used for air-to-ground attacks. Flares are used for night illumination of ground locations.

7.6 AN/APQ-159(V)-3 Radar

The AN/APQ-159(V)-3 radar provides for air target search, lock-on, and tracking for head-on and stern attacks in open airspace.

The AN/APQ-159(V)-3 consists of:

- Antenna
- Transmitter-receiver
- Processor

- Control panel
- Radar indicator in cockpit

AN/APQ-159(V)-3 Radar Controls

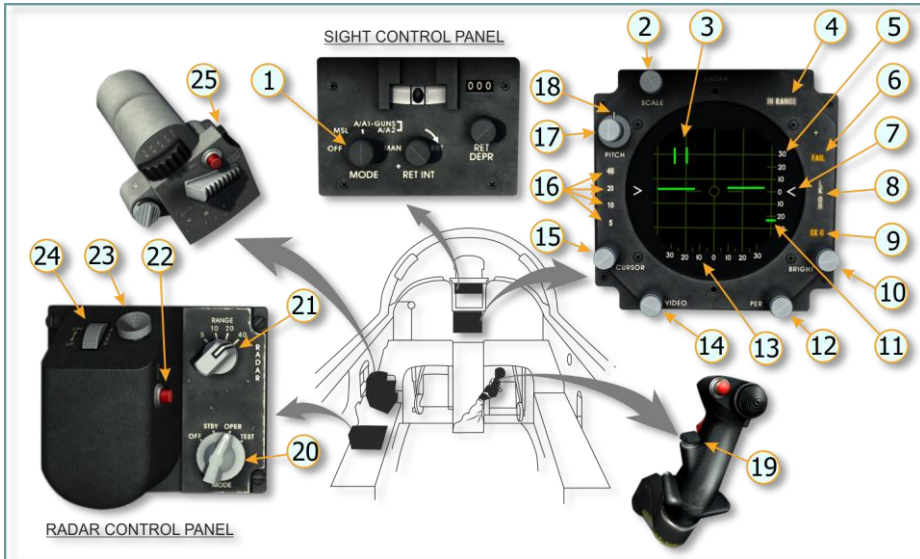

Figure 7.5 Radar Controls and Indicators in Cockpit

No.	Element	Function
1.	Sight MODE Selector	OFF – Disconnects electrical power to AN/ASG-31. MSL – Selects missile mode for fire control system. A/A1 or A/A2 GUNS – Selects gun mode for fire controls system. MAN – Selects manual mode for AN/ASG-31.
2.	Scale Knob	Adjusts brightness of azimuth and range grid lines, azimuth and elevation scales, and missile steering circle from off to full bright.
3.	Acquisition Symbol	Provides target bracketing and acquisition. Displayed on radarscope in search and acquisition phases. Not displayed in 40-mile range.
4.	IN RANGE Light	Indicates permissible range. IN RANGE is steady on – Target in range for missile launch or gun attack. IN RANGE is flashing – Target range is less than minimum range for missile launch or gun attack

No.	Element	Function
5.	Elevation Scale	Allows determining antenna elevation tilt angle.
6.	FAIL Light	Illumination indicates radar failure.
7.	ARL Mark	Indicates armament reference line.
8.	LK ON Light	Illuminates when radar is locked on and during range-tracking target.
9.	Excess G Light	Indicates excess-g condition for successful missile guidance.
10.	Bright Knob	Adjusts background brightness of radarscope from off to full bright.
11.	Elevation Cursor	Indicates antenna elevation tilt angle.
12.	Persistence PER Knob	Adjusts time the video remains on radarscope.
13.	Azimuth Grid	Allows determining azimuth of target
14.	Video Knob	Adjusts video intensity over ground clutters in MSL mode. Inoperative in DM, DG, and GUN modes.
15.	Cursor Knob	Adjusts brightness of horizon bar, elevation cursor, acquisition symbol and aim symbol on radarscope from off to full bright.
16.	Range Scale Lights	Indicates radar operating range in nautical miles.
17.	PITCH Knob	Adjusts horizon bar 20 degrees up or down.
18.	Pitch Index Mark	Used to set horizon bar to zero position on radarscope.
19.	Dogfight/Resume Search Switch	<p>1. Center Position (Momentary Press): In MSL mode – initiates search phase or breaks lock if radar was locked on. In DM and DG modes – rejects selected dogfight mode, breaks lock if radar was locked on, and initiates search phase. In GUNS mode – initiates search phase and breaks lock if radar was locked on.</p> <p>2. Aft Position (Momentary Press): Selects DG mode and deactivates normal release system. After DG mode selection, antenna aligns to 0 degrees azimuth and 4.7 degrees below armament reference line (ARL). Range gate slews from 500 to 5600 feet to lock on the first target encountered.</p> <p>3. Forward Position (Momentary Press): Selects DM mode and deactivates normal release system. After DM mode selection, antenna aligns to 0 degrees azimuth and on ARL. Range gate slews from 500 to 30,000 feet to lock on the first target encountered.</p> <p><i>NOTE:</i> DM and DG modes have higher priority over other modes. Selecting DM and DG modes deactivates any other operating mode.</p>

No.	Element	Function
		<p>When the radar is locked on to a target in DM or DG mode, reselecting the same dogfight mode breaks target lock-on. Range gate slews out from rejected target to lock on to the first target that is at least 450 feet or greater in range.</p> <p>Actuation and holding of the dogfight/resume search switch in forward or aft position causes the range gate to return and stow at minimum range.</p>
20.	Radar Mode Selector	<p>Selects radar operation mode</p> <p>OFF – Disconnects electrical power to radar.</p> <p>STBY – Connects electrical power to warm up radar (3 to 5 minutes). Within 60 seconds after warm-up, the following appear on indicator: Horizon bar Antenna elevation cursor Acquisition symbol Range scale</p> <p>OPER – Connects electrical power to all circuitry for radar search and track operation. If switching to OPER bypassing STBY, no search and track operation will be available until warm-up is completed (3 to 5 minutes).</p> <p>TEST – Activates radar built-in-test circuits.</p>
21.	Range Selector	<p>Selects radar range. Range is indicated in nautical miles.</p>
22.	Acquisition (ACQ) Button	<p>Press (Momentary) – locks on to target or breaks lock-on.</p> <p>In MSL Mode: Compresses B-sweep at the target bracketed by acquisition symbol and moves to 20-degree left azimuth after radar lock-on to facilitate aiming. If locked on, pressing button breaks target lock-on and the acquisition symbol automatically reappears at last known azimuth and range position of target to commence the acquisition process.</p> <p>In GUN Mode: stows B-sweep 20 degrees left in azimuth. Aligns antenna 0 degrees azimuth and 4.7 degrees below ARL. Range gate slews from 500 feet to 5600 feet and locks on to target after its acquisition.</p> <p>In DG и DM modes: If locked on, breaks target lock-on. Range gate resumes slewing from rejected target to lock on to the first target that is at least 450 feet or greater in range.</p>

No.	Element	Function
		Holding the button pressed stows the range gate at minimum range. <i>NOTE: Holding button pressed will prevent radar lock-on.</i>
23.	Target Designator Control (TDC) Button	Positions acquisition symbol. Acquisition symbol can be positioned by button out to maximum range of 10 miles.
24.	Elevation (ELEV) Antenna Tilt Control	Adjusts antenna tilt angle 45 degrees up and 40 degrees down relative to aircraft ARL.
25.	Sight Cage Switch	Holding switch pressed aligns radar antenna to ARL in acquisition and track phase of DM, DG and GUNS modes. If locked on, the radar will continue to track target. Releasing switch causes antenna to go back to previous azimuth and elevation position.

Range Gird

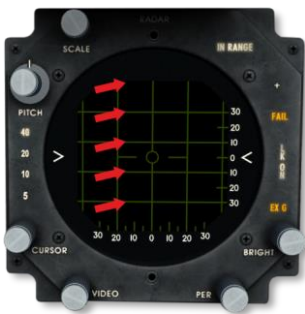

Allows the pilot to determine target range on the scope of radar indicator based on range indicated by the range scale light.

40 – 40, 32, 24, 16 and 8 miles

20 – 20, 16, 12, 8 and 4 miles

10 – 10, 8, 6, 4 and 2 miles

5 – 5, 4, 3, 2 and 1 miles

Top edge of the scope corresponds to a maximum range of 40, 20, 10, or 5.

First horizontal line corresponds to a range of 32, 16, 8, or 4.

Second horizontal line corresponds to a range of 24, 12, 6, or 3.

Third horizontal line corresponds to a range of 16, 8, 4, or 2.

Fourth horizontal line corresponds to a range of 8, 4, 2, or 1.

7.7 AN/ASG-31 Lead Computing Optical Sight System

The AN/ASG–31 system aids aiming during air-to-air firing of the AIM–9 missiles and guns, air-to-ground guns firing, and air-to-ground delivery of bombs and rockets. The system computes and displays launch envelope for AIM-9 missile on the radar indicator and on the sight reticle as well as lead for air-to-air gun firing on optical sight in MSL, DM, DG, and A/A1 or A/A2 modes.

The AN/ASG–31 consists of:

- Gyro Lead Computer (GLC)
- Optical Display Unit (ODU)

The AN/ASG-31 may be used in conjunction with the AN/APQ-159 or separately during air-to-air attacks.

When only the AN/ASG-31 is used for air-to-air attacks, the reticle does not display range bar, range indexes, in-range, minimum-range, and excess-g markers. In this case, distance to a target can be estimated by comparing visible target size with reticle circle diameter.

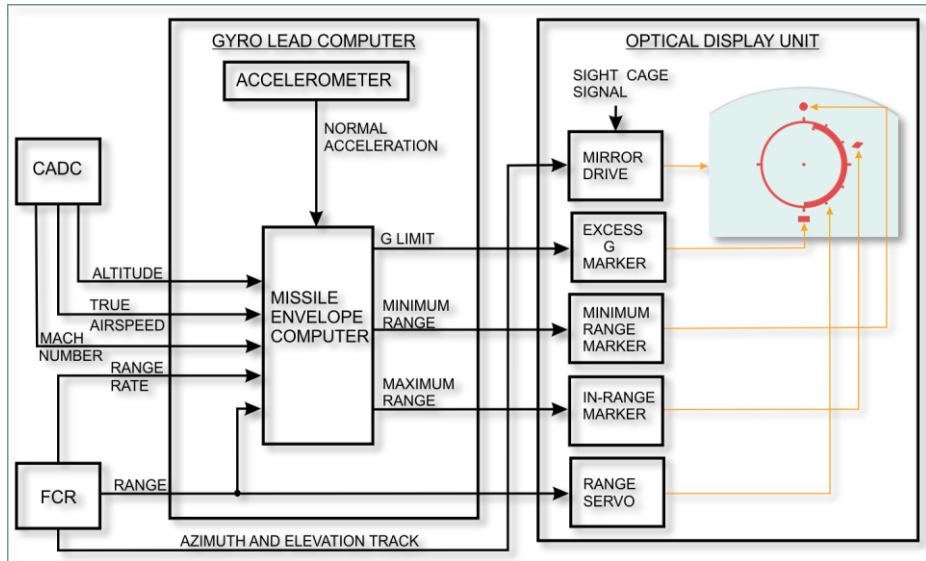

Figure 7.6 AN/ASG-31 and AN/APQ-159 Joint Operation in Missile Mode

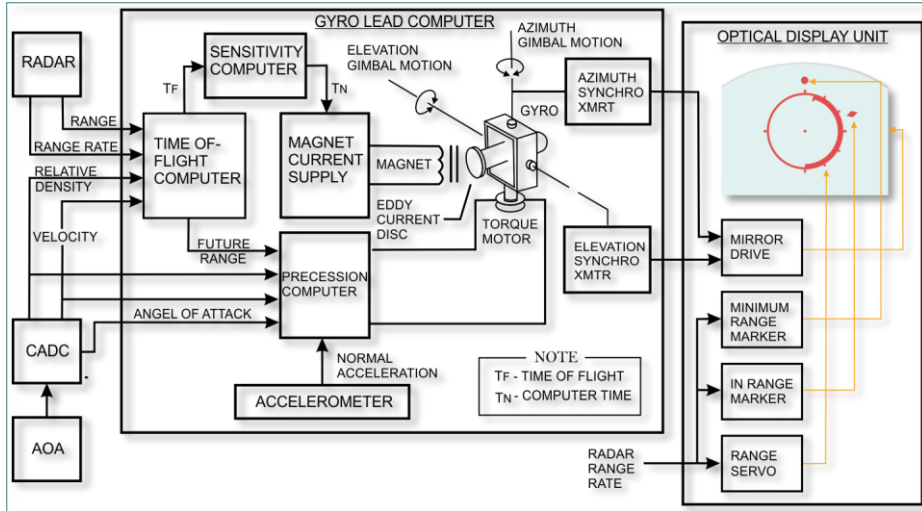

Figure 7.7 AN/ASG-31 and AN/APQ-159 Joint Operation in Gun Mode

AN/ASG-31 Controls

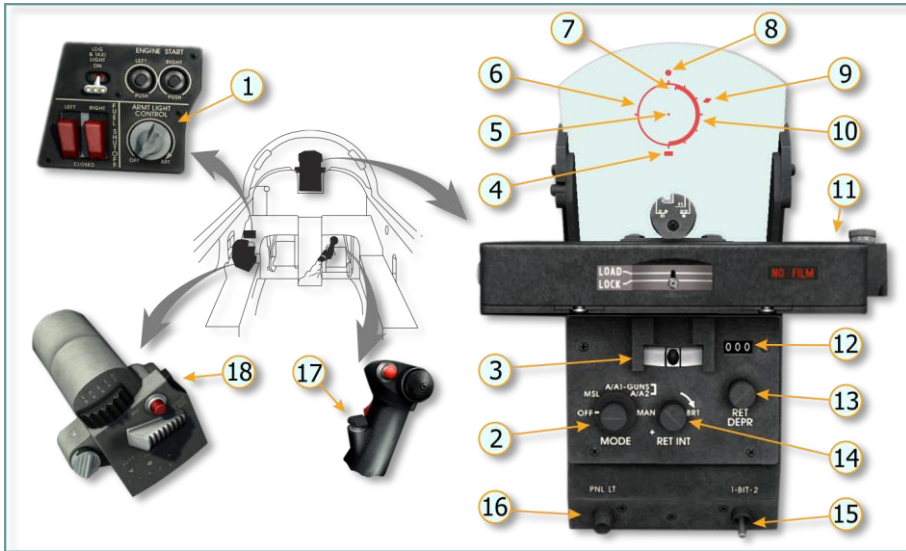
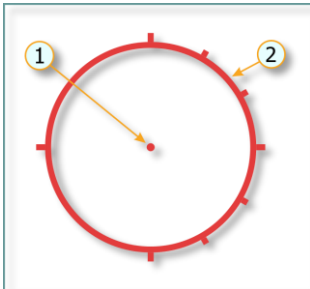

Figure 7.8 Optical Sight Controls and Indicators

No.	Element	Function
1.	Armament Panel Light Knob	Adjusts light intensity of armament panel and AN/ASG-31 sight panel.
2.	Mode Selector	OFF – Disconnects electrical power to AN/ASG-31. MSL – Selects missile mode. Aligns reticle pipper to ARL in missile mode. A/A1 GUNS – Selects guns mode for maneuvering target. A/A2 GUNS – Selects guns mode for unaccelerated constant rate maneuvering target. MAN – selects AN/ASG-31 manual control mode.
3.	Slip Indicator	Indicates aircraft skid or slip.
4.	Excess-g marker	Illumination indicates that G-forces affected on aircraft is in excess of values for missile firing.
5.	Pipper	A 2-mil diameter aiming reference in center of reticle.
6.	Reticle	A 50-mil diameter sight reticle circle containing aiming markers. In case of reticle failure, distance to a target can be estimated by comparing visible target size with reticle circle diameter.
7.	Range Bar	Indicates current distance to target.
8.	Minimum-Range Marker	Indicates that target range is equal or less than the computed missile minimum launch range.
9.	In-Range Marker	Indicates that target range is within launch envelope.

No.	Element	Function
10.	Range Index	Used to determine distance to target.
11.	Sight Camera	Ref. Section 7.4
12.	RET DEPR Readout Window	Indicates reticle depression in MAN mode
13.	RET DEPR Knob	Selects reticle depression in MAN mode. Reticle depression is measured in mils.
14.	RET INT Knob	Adjusts light intensity of reticle.
15.	1-BIT-2 Switch	Provides activation of sight built-in-test circuits.
16.	PNL LT Button	Push On – Turns on AN/ASG-31 sight panel light. Push Off – Turns off AN/ASG-31 sight panel light.
17.	Dogfight/Resume Search Switch	Center Position (Momentary Press) Rejects DM and DG modes. Aft Position (Momentary Press) Selects DG mode. Forward Position (Momentary Press) Selects DM mode.
18.	Sight Cage Switch	Holding switch pressed electrically cages (aligns) pipper to ARL in all modes. Releasing switch causes pipper to return to its position prior the switch was pressed.

Reticle



Reticle appearance less aiming markers.

1. Pipper. Diameter: 2 mil.
2. Reticle Circle. Inner Diameter: 50 mil.

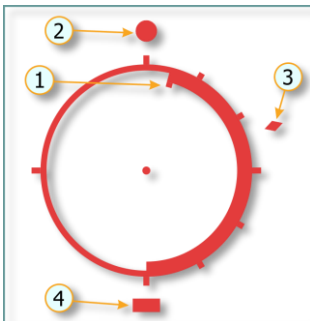

Reticle appearance with aiming markers.

1. Range Bar.
2. Minimum-Range Marker.
3. In Range Marker.
4. Excess-G Marker.

The sight reticle consists of a pipper and circle.

After radar locks-on to the target, aiming markers appear on the circle.

The range bar extends from the 6-o'clock position on the inner right side of the circle toward the 12-o'clock position, depending on the target range.

Each range index indicates 1000 feet in gun modes and 10,000 feet in missile mode. The range indexes are located on the outer right side of the circle.

When the leading edge of the range bar is at the 6-o'clock position, range to the target is 60,000 feet in missile mode and 6000 feet in gun modes.

Decrease in target range causes the bar to move towards 12-o'clock position, and when the target range is within the permissible launch envelope, an in-range marker appears.

The in-range marker disappears when the target is beyond launch envelope.

When the target range is equal to minimum launch range or less, a minimum-range marker appears.

7.8 AN/APQ-159(V)-3 System Operation Modes

The radar may operate in the following air-to-air modes:

- MSL;
- DM Dogfight Missile;
- DG Dogfight Guns;
- A/A1 GUNS;
- A/A2 GUNS.

During air-to-air attack the AN/APQ-159(V)-3 usually is interfaced with the AN/ASG-31.

When the AN/APQ-159 is used in conjunction with the AN/ASG-31, the IN-RANGE light illuminates/ flashes on the radar indicator and, under excessive g-load condition, the EX G light comes on. This information is not displayed when the radar is used separately.

When the AN/APQ-159 is used in conjunction with the AN/ASG-31, the reticle displays range bar, range indexes, in-range, minimum-range, and excess-g

information. When the sight system is used separately, the above information will not be displayed.

Modes involving joint operation of the AN/APQ-159 and AN/ASG-31 will be described in the text below.

MISSILE(MSL) MODE

This mode provides target search, acquisition, lock-on, and tracking when firing the AIM-9 missiles.

The mode is used in long-range missile combats at distances up to 40 miles.

The mode can be selected on the AN/ASG-31 control panel.

1. SEARCH PHASE (Target detected left and low)



1. 40-mile range
2. Target (20° left at 32 nm)
3. B-sweep (sweeping)
4. Elevation cursor (antenna looking down 20° below ARL)

The search pattern is a two-bar antenna scan depending on the radar operating range.

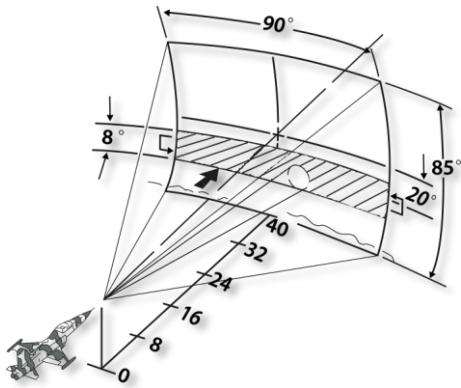

40-mile range.
Antenna scan covers 90° in azimuth and 4° below and above antenna centerline.

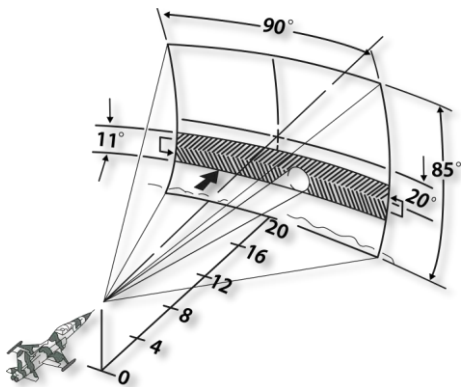

20-, 10- and 5-mile range.
Antenna scan covers 90° in azimuth and 5.5° below and above antenna centerline.

2. READY FOR ACQUISITION



- 1. 20-mile range
- 2. B-sweep (sweeping)
- 3. Elevation cursor
- 4. Acquisition symbol (ACQ). Distance between vertical lines is 2200 feet in 5-mile range and 4400 feet in 20- and 10-mile range.
- 5. Target (20° right at 8 nm)

3. ACQUISITION PHASE

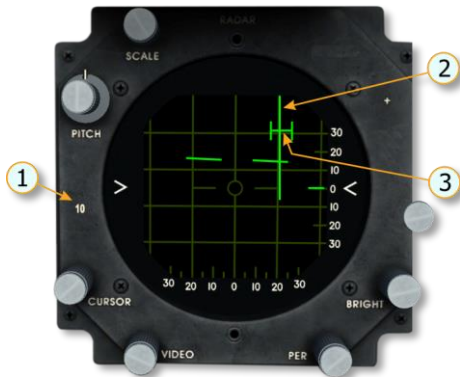

- 1. 10-mile range
- 2. B-sweep (sweeping)
- 3. Target bracketed by acquisition symbol

Pressing ACQ button (located on AN/APQ-159 control panel) spotlights target. Range scale automatically changes to 10. Antenna starts scanning ± 5 degrees in azimuth and ± 1.5 degrees in elevation.

4. LOCK-ON - TRACKING PHASE

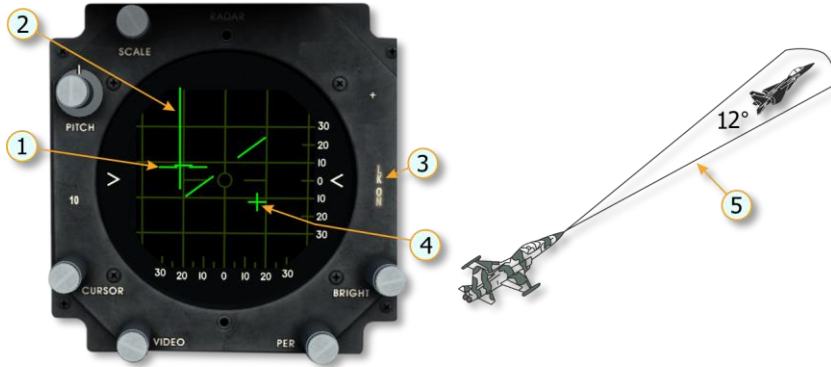

- 1. Range gate (on target at 6 nm)
- 2. B-sweep (stows 20° left)
- 3. LK ON light

- 4. Aim symbol (target low and right)
- 5. After lock-on, antenna conically scans about the target with 12° span

5. MISSILE LAUNCH

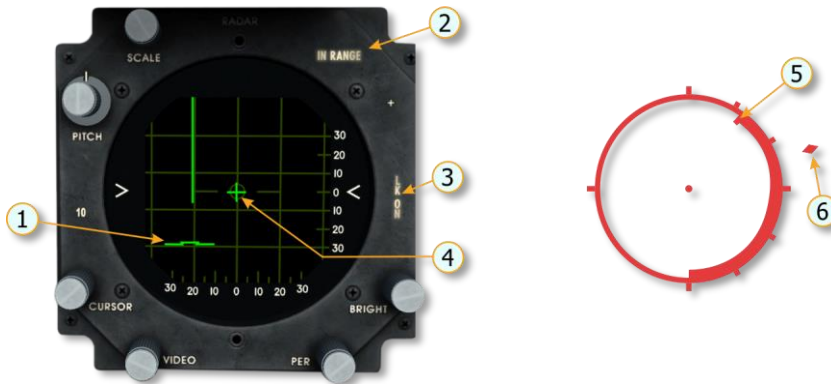

- 1. Target at 2 NM
- 2. IN RANGE light (steady)
- 3. LK ON light

- 4. Aim symbol
- 5. Range bar at 12,000 feet
- 6. In-range marker

When minimum launch range is reached, the IN RANGE light on the radar indicator flashes and the minimum-range marker appears on the sight reticle.

When g-load for successful missile guidance is exceeded, the EX G light on the radar indicator comes on and the excess-G marker appears on the reticle.

NOTE: The range bar, in-range, minimum-range and excess-G markers are displayed only when the radar operates in conjunction with the sight system.

Maximum acquisition range (R_A) and lock-on range (R_{Lo}) in MSL mode depend on target flight altitude, type, and direction relative to the fighter.

Maximum acquisition range and lock-on range for different target types at head-on attack are given in the [Table 7.1](#)

NOTE: The B-52 is used as a bomber target and the F-4 as a fighter

Table 7.1 Acquisition and Lock-on Range at Head-on Attack

Target type	Altitude (feet)	R_A (miles)	R_{Lo} (miles)
Bomber	>5000	≈40	≈10
Fighter	>5000	≈16.6	≈10
Bomber	<5000	≈24	≈10
Fighter	<5000	≈10	≈8.5

Maximum acquisition and maximum lock-on ranges for different target types at stern attack are given in the [Table 7.2](#)

Table 7.2 Acquisition and Lock-on Range at Stern Attack

Target type	Altitude (feet)	R_A (miles)	R_{Lo} (miles)
Bomber	>5000	≈13	≈10
Fighter	>5000	≈5.5	≈5
Bomber	<5000	≈8	≈6.8
Fighter	<5000	≈5	≈4.5

DOGFIGHT MISSILE (DM) Mode

This mode provides target search, acquisition, and lock-on when firing AIM-9 missiles.

The mode shall be used in short-range air-to-air combats.

It is recommended to perform target search and acquisition in 20-mile range before selecting DM mode.

After mode selection, if the target is within the range of 500 to 30,000 feet, the radar automatically locks on to the target.

1. SEARCH PHASE (Target detected left and low)

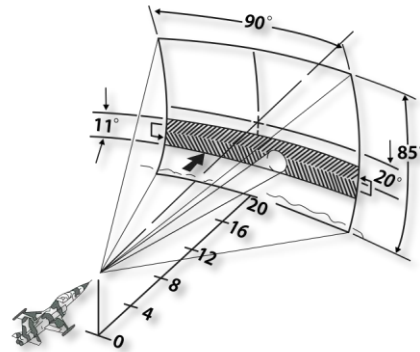
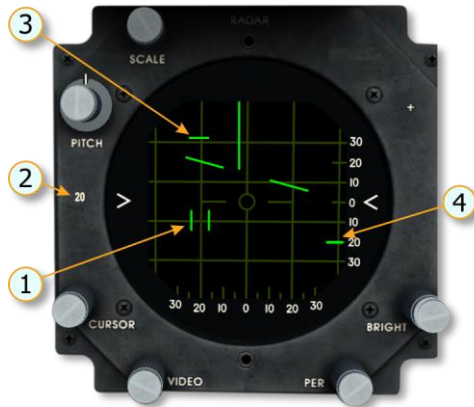

1. Acquisition symbol (not active in this mode)
2. 20-mile range
3. Target (20° left at 16 nm)
4. Elevation cursor (Antenna looking down 20° below ARL)

2. READY FOR ACQUISITION

Maneuver aircraft to center target on 0° azimuth and elevation.



1. Target (0° azimuth at 8 nm)
2. Elevation cursor (0° elevation)

3. ACQUISITION PHASE

Selecting DM mode (on aircraft control stick) aligns antenna to 0° azimuth and on ARL and range scale changes to 10 miles. Range gate slews from 500 to 30,000 feet to lock on the first target encountered.

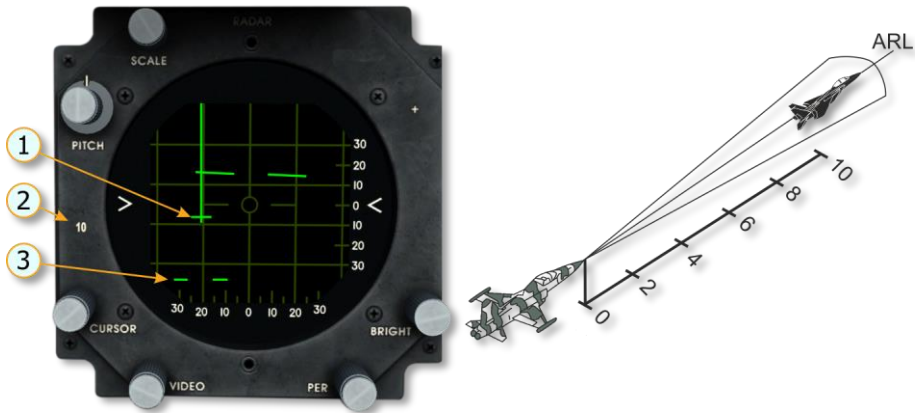

1. Target (at 4.2 nm)
2. 10-mile range
3. Range gate (slews out to lock on target)

4. LOCK-ON - TRACKING PHASE

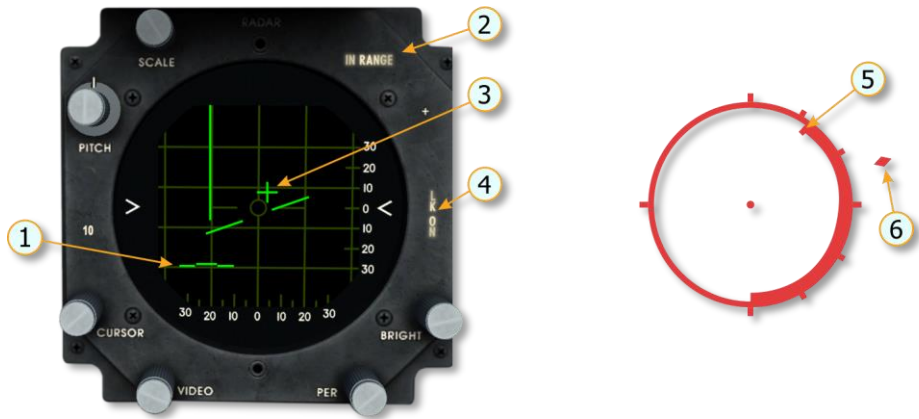

- | | |
|---------------------------------------|-----------------------------|
| 1. Range gate on target (2 nm) | 4. LK ON light |
| 2. IN-RANGE light (steady). | 5. Range bar at 12,000 feet |
| 3. Aim symbol (target high and right) | 6. In-range marker. |

If radar lock-on is lost, in-range marker and range bar will disappear from sight reticle.

When minimum launch range is reached, IN RANGE light on the radar indicator flashes and the minimum-range marker appears on the sight reticle.

When g-load for successful missile guidance is exceeded, the EX G light on the radar indicator comes on and the excess-G marker appears on the reticle.

The range bar, in-range, minimum-range and excess-G markers are displayed only when the radar operates in conjunction with the sight system.

DOGFIGHT GUN (DG) Mode

This mode provides target search, acquisition, and lock-on during guns firing. The mode is used in short-range combats against maneuvering targets with different angular rates.

It is recommended to perform target search and acquisition in 10-mile range before selecting DG mode. After mode selection, if the target is within the range of 500 to 5600 feet, the radar automatically locks on to the target.

The effective range of the guns is 2700 to 1000 feet. You must consider that projectile flight time for 2700-foot range is approximately 1 second, 0.7 seconds for 2000 feet, and 0.3 seconds for 1000 feet.

1. SEARCH PHASE (Target detected left and low)

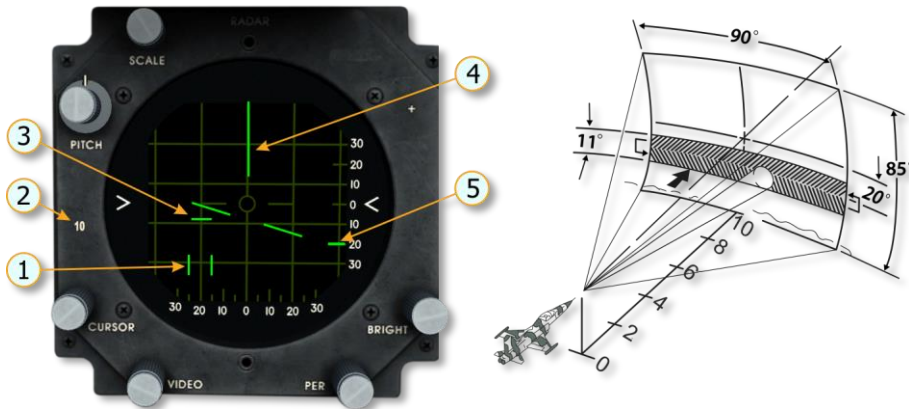

- 1. Acquisition symbol (is not active in this mode)
- 2. 10-mile range
- 3. Target (20° left at 4 nm)
- 4. B-sweep (sweeping)
- 5. Elevation cursor (antenna looking down 20° below ARL)

2. READY FOR ACQUISITION

Maneuver the aircraft to center target on 0° azimuth and slightly below ARL.



1. Target (0° azimuth at 3 nm)

2. Elevation cursor (0° elevation)

3. ACQUISITION PHASE

Selecting DG mode (on aircraft control stick) aligns antenna to 0° azimuth and 4.7° below ARL. Range scale changes to 5. Range gate slews from 500 to 5600 feet to lock on the first target encountered.

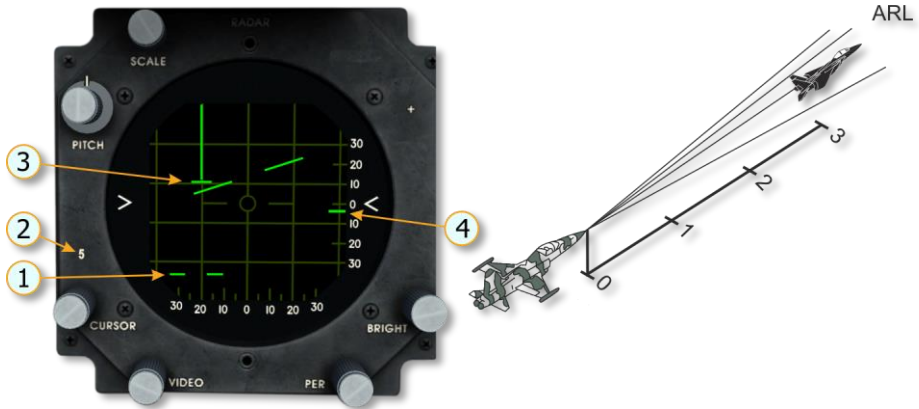

1. Range gate
2. 5-mile range

3. Target (on compressed b-sweep at 3 nm), B-sweep (stows 20° left)
4. Elevation cursor (-4.7° elevation)

4. LOCK-ON - TRACKING PHASE

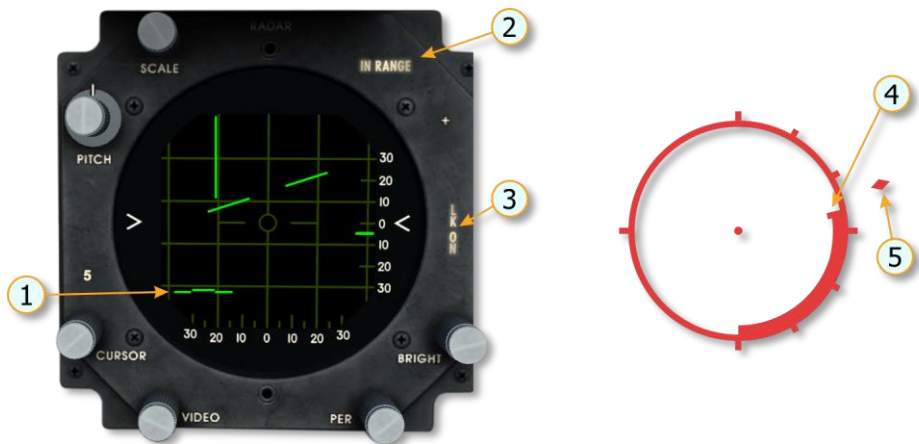

1. Range gate on target (2700 ft)
2. IN RANGE light (steady).
3. LK ON light.
4. Range bar at 2700 feet
5. In-range marker

Note: If radar lock-on is lost, the IN-RANGE light goes off and the range bar will disappear from the sight reticle.

When minimum launch range is reached, IN RANGE light on the radar indicator flashes and the minimum-range marker appears on the sight reticle.

A/A1 GUNS Mode

This mode is similar to DG.

The mode is selected on the AN/ASG-31 control panel.

Pressing the ACQ button initiates lock-on to the target.

ATTACK IN DG AND A/A1 MODE (NONTRACKING SOLUTION "SNAPSHOT")

The nontracking solution (snapshot) should be used only in DG/A/A1 gun mode when unable to track a maneuvering target.

The sight system provides a momentary solution to the aiming problem. Start to fire one projectile time-of-flight before the pipper reaches the target future position ([Figure 7.9](#)). The aim and open fire point is no longer the target position as in tracking solution because pipper displacement results from the relative motion of the target to the pipper.

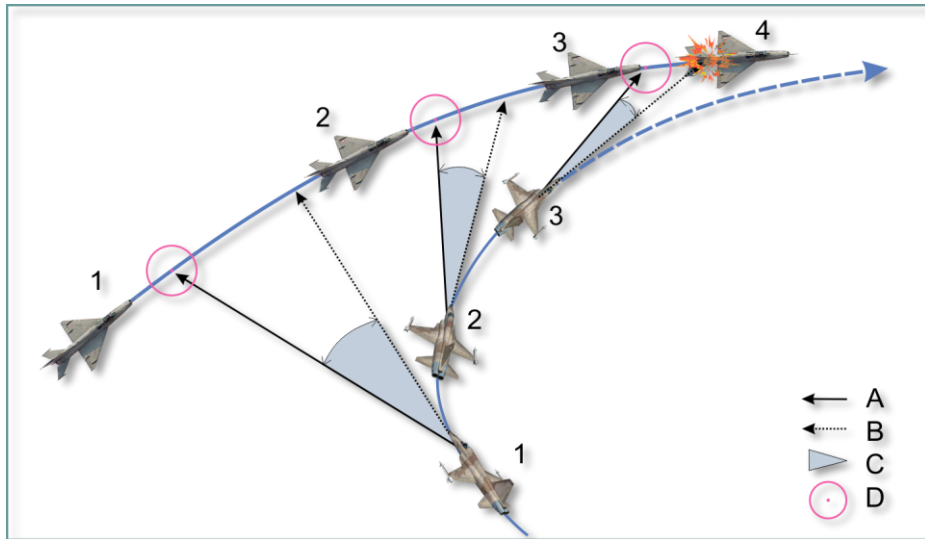

Figure 7.9 Attack in DG and A/A1 Mode

- | | |
|---|--|
| A. Line of sight | 1. Attacker and target positions at attack initiation. |
| B. Gunline | 2. Attacker and target positions at aiming. |
| C. Lead angle (only correction for projectile ballistic trajectory) | 3. Attacker and target positions at firing. |
| D. 50-mil reticle. | 4. Target impact. |

The task is to project target and piper motion to a point of intersection and to fire approximately one projectile time-of-flight before intersection would occur. It is not necessary that the piper and target actually intersect. Rather they need only to appear to approach intersection one projectile time-of-flight later.

Figure 7.10 illustrates the nontracking (snapshot) technique and shows the piper at 1-second intervals during an attack. Assuming a projectile time-of-flight of 1 second, if firing is initiated at position 2 and piper and target motion are such that the piper would have been at position 3 one second later, hits will occur at position 3. If firing is continued from position 2 to position 3 and piper and target motions are constant during this period such that the piper would have moved from position 3 to position 4 in the next 1-second interval, hits occur from position 3 toward position 4.

The rate of convergence of the piper with the target determines the projectile concentration at the target. A relatively low rate of convergence (5 to 15 mils per second) is optimum for projectile concentration and estimating the timing of the firing burst. An attack in the plane of the target makes estimation easier. The piper may be brought to the target from any direction. In either the tracking or snapshot attacks, move the controls smoothly to reach and maintain firing position. Allow for 0.25 second delay in firing after squeezing the trigger caused by operation of the gun gas purging and deflector system, if not already opened.

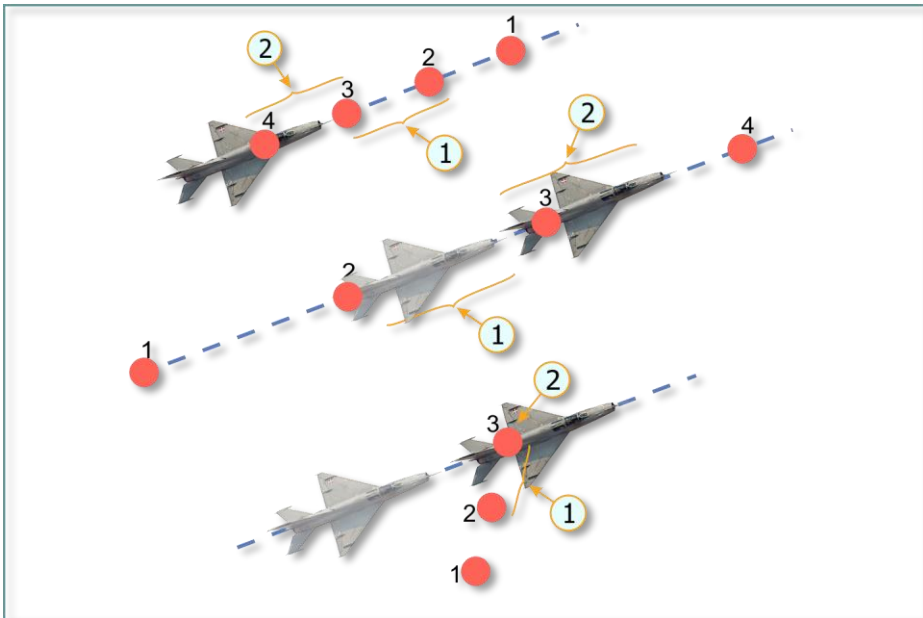

Figure 7.10 Nontracking solution (Snapshot)

1. Fire
2. Hits

A/A2 GUNS Mode (TRACKING SOLUTION)

This mode provides target search, acquisition, and lock-on during gun firing. The mode is selected on the AN/ASG-31 control panel.

The mode is primarily used in short-range air-to-air combats against unaccelerated constant rate maneuvering target. It is recommended to perform target search and acquisition in 10-mile range before selecting A/A2 mode. After mode selection, if the target is within the range of 500 to 5600 feet, the radar automatically locks on to the target.

The pipper is displayed one projectile time-of-flight from the gun line for the rate the attack aircraft is turning and target range. When tracking, the pipper remains one time-of-flight away from target future position to provide a continuous solution to the aiming problem. Keep the pipper on the target while turning and firing to direct the projectiles to the target future position for hits. Track the target for 1/2 second to eliminate any motion between the pipper and target before firing. Keep the pipper motionless on the target to get maximum concentration of hits (figure 7.10). Any pipper motion with respect to the target can result in misses.

The effective range of the guns is 2700 to 1000 feet. Pressing the ACQ button initiates lock-on to the target.

Aiming information on the radar indicator and sight reticle is similar to those in DG (A/A1) modes.

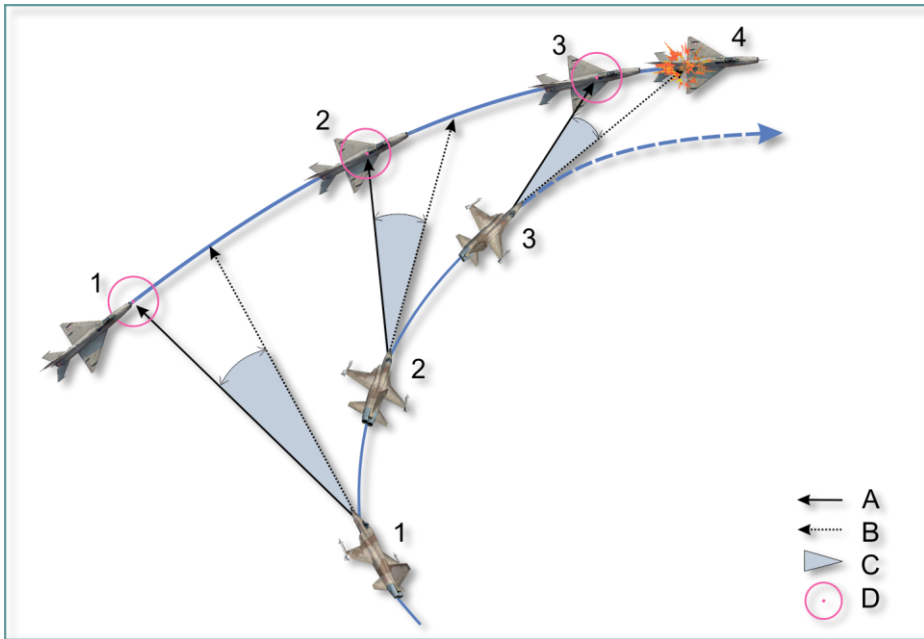

Figure 7.11 Attack in A/A2 Mode

- | | |
|---|--|
| A. Line of sight | 1. Attacker and target positions at attack initiation. |
| B. Gunline | 2. Attacker and target positions at aiming. |
| C. Lead angle (with correction for projectile ballistic trajectory) | 3. Attacker and target positions at firing. |
| D. 50-mil reticle | 4. Target impact. |

7.9 AN/ASG-31 System Operation Modes

The optical sight system may operate in the following modes:

- MSL;
- A/A1 GUNS;
- A/A2 GUNS;
- MAN.

MISSILE(MSL) MODE

The mode is used for application of the AIM-9 missiles. Launch the missiles after a sound indicating that the seekers are locked on and track the target is heard. Distance to a target and launch distance can be estimated by comparing visible target size with reticle circle diameter [Figure 7.12](#). The mode can be deselected on the AN/ASG-31 control panel.

A/A1 GUNS and A/A2 GUNS MODES

When the optical sight system is used during gun firing, the gyro lead computer (GLC) is capable of computing a lead angle at a distance of 1500 feet and at closing speed of 90 kt.

The A/A1 GUNS mode is used against maneuvering target.

The mode is selected on the AN/ASG-31 control panel.

Figure illustrates aiming technique [Figure 7.9](#)

The A/A2 GUNS mode is used against the unaccelerated constant rate maneuvering target.

The mode is selected on the AN/ASG-31 control panel.

Figure illustrates aiming technique [Figure 7.11](#)

Distance to a target and firing distance can be estimated by comparing visible target size with reticle circle diameter [Figure 7.12](#)

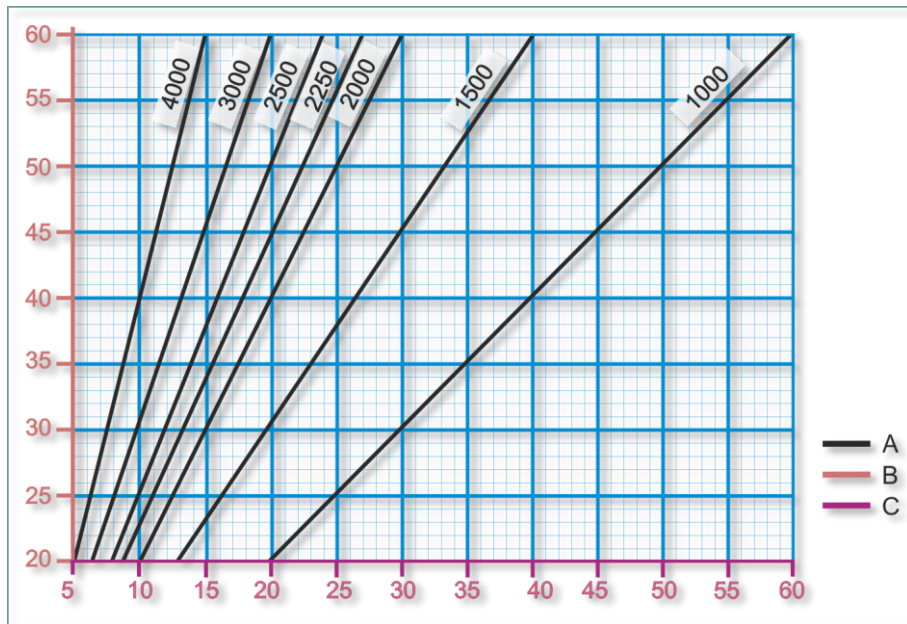

Figure 7.12 Target Range Assessment Chart

- A. Target range (feet)
- B. Actual target wingspan (feet)
- C. Apparent target wingspan (mils)

MAN MODE

The manual mode is used for application of the bombs, rockets and guns during air-to-ground attack. The mode is selected on the AN/ASG-31 control panel. In this mode, roll stabilization compensates the reticle for bank angles up to $\pm 22.5^\circ$, allowing $\pm 22.5^\circ$ bank deviations after the pipper is positioned on the target.

If these conditions are observed, the pipper will stay on the target.

The MAN mode can be used as a backup mode when the MSL, DM, DG, A/A1, and A/A2 modes fail. In this case, sight reticle depression should be set to 0 degrees.

If the radar is used, only the range bar will be displayed on the sight reticle.

In the MAN mode, the range index indicates 1000 feet.

The in-range, minimum-range, and excess-g markers are not displayed. Approximation of target range can be obtained by comparing the target size with the reticle diameter. Launch the missiles after a sound indicating that the seekers are locked on and track the target is heard. Distance to a target and firing distance can be estimated by comparing visible target size with reticle circle diameter [Figure 7.12](#).

7.10 Missiles

The AIM-9P air-to-air missile can be installed on the wingtip launchers.



The AIM-9P Sidewinder is a US air-to-air missile with infrared seeker. The missile entered US Air Force service in 1956 and became the world's first most efficient air-to-air guided missile. The missile underwent a series of modifications and is widely used in many air forces worldwide till nowadays.

Table. AIM-9P specifications

Weight, lb/kg	165/75
Length, in/cm	112/284.48
Seeker field-of-view, deg	4
Gimbal limits, deg	± 26
Maximum guided flight time, sec	20
Sun lock-on envelope, deg	20

Seeker lock-on range highly depends on altitude, speed, g-load, flight attitude, presence of the sun in the missile line of sight. An audio tone is heard in pilot's headsets whenever a seeker is locked on to the target.

7.11 Bombs

Mk-82

The Mark 82 is an air-dropped general purpose aircraft bomb developed in the 1950s.



The nominal weight of the bomb is 531 lb (240 kg), although its actual weight varies depending on its configuration. The bomb has a metal body filled with 191 lb (87 kg) Tritonal explosive. The Mk 82 is used as a warhead for GBU-12 and GBU-38 JDAM laser-guided bombs. The Mk-82 can be attached to all pylons of the aircraft.

Mk-83

The Mark 83 is an air-dropped general purpose aircraft bomb developed in the 1950s.



The bomb is a part of Mark 80 series bombs being in US Air Force service. The nominal weight of the bomb is 985 lb (446 kg), although its actual weight varies depending on its configuration. The bomb has a metal body filled with 445 lb (202 kg) Tritonal explosive. The Mk 83 is used as a warhead for GBU-

16 and GBU-32 laser-guided bombs. The Mk-83 can be attached only to centerline and inboard pylons.

Mk-84

The Mark 84 is a general purpose aircraft bomb developed in the 1950s, which entered into service during Vietnam War.



The bomb is the largest of Mark 80 series bombs. The nominal weight of the bomb is 1970 lb (908 kg), although its actual weight varies from 1972 lb (896 kg) to 2083 (947 kg) depending on its configuration. The bomb has a metal body filled with 945 lb (429 kg) Tritonal explosive. It can penetrate 380 mm of metal or 3.3 m of concrete. The Mk-84 can be attached only to the centerline pylon.

Mk-82 Snakeye

The Mark 82 Snakeye is an air-dropped general purpose bomb with a high drag tail fins.



The Mark 82 Snakeye is used for low-level bombing (100 feet minimum) and equipped with rigid high-drag cruciform shape tail fin unit. When the bomb is released and exposed to ram air, a special spring opens the fins into cruciform shape, thus increasing bomb fall time and allowing the aircraft to fly

to a safe distance from the point of bomb impact. The bomb weight is 570 lb (258 kg). The Mk-82 Snakeye can be attached to all pylons of the aircraft.

M117

The M117 is an air-dropped general purpose bomb developed in the 1950s.



The bomb nominal weight is 824 lb (373 kg), although its actual weight varies depending on its configuration. The bomb has a metal body filled with 403 lb (183kg) Tritonal explosive. The M117 can be attached to all pylons of the aircraft.

CBU-52B

The CBU-52B/B is a general purpose cluster.



The CBU-52B/B is loaded with 220 BLU-61A/B anti-material, anti-personnel submunitions. Scattering area depends on the altitude of dispenser actuation. CBU-52B/B can be attached to all pylons of the aircraft.

The BLU-61A/B is a high-explosive fragmentation bomblet.

7.12 Guided Bomb

The F-5E can use the GBU-12 PAVEWAY II guided bombs against targets that are laser-illuminated by ground units or other aircraft.



The GBU-12 weighs 611 lb (277 kg) and is a general purpose guided bomb equipped with the Mk-82 as a warhead. A nose-mounted laser seeker detects a laser designator with the same coding as the coding of the receiver. After bomb release, the fins in the bomb tail unfold and guide the bomb to the laser spot. The guidance system does not constantly control bomb trajectory but sends a series of control signals necessary to guide the bomb precisely to the target. Such guidance technique is called a pulse correction.

Typical targets of the GBU-12 are large and/or armored objects, where an accurate and powerful shot is needed. These are bridges, bunkers, and strongpoints.

7.13 Rockets

F-5E may use a wide range of 2.75-inch rockets loaded in LAU-68 or LAU-3 launcher which are used against non-armored or light-armored targets.



The LAU-3 is capable of being loaded with nineteen 2.75-inch rockets.



The firing of the rockets is controlled by an electromechanical intervalometer. The intervalometer is mounted in the aft of the launcher and the main purpose of the unit is to generate electric pulses supplied to rocket electric squibs. The intervalometer is also used to select firing mode (single or ripple). Selection for single or ripple must be made before starting engines. The LAU-68 is capable of being loaded with seven 2.75-inch rockets. The fire is controlled and firing mode is selected in the same way as for the LAU-3.

The LAU-3 and LAU-68 can be carried on the outboard and inboard pylons.

7.14 Flares

The F-5E can use parachute flares for night illumination of combat field for ground forces. The LUU-2 flares are loaded into SUU-25 dispensers, 8 flares per each dispenser. After release, a preset timer deploys the parachute and ignites the flare. The LUU-2 flares use magnesium and are capable of

illuminating the area 500 meters in diameter from 1000 feet altitude. The flare burns for approximately 270 seconds. The SUU-25 dispenser can be carried on the outboard pylons.

7.15 Guns

The F-5E has two M-39A3 20 mm guns mounted in the upper forward section of the fuselage.

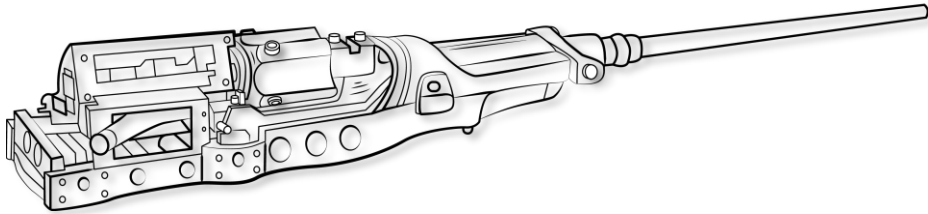

The gun fires at 1500 to 1700 rounds per minute. Each gun has capacity of 280 rounds. The guns have a purging system for removing explosive gases and to prevent ingestion of these gases into the engines. During firing, the gun purge doors open and purge system is activated.

7.16 MXU-648 Cargo Pod

The pod is used during aircraft ferrying for transportation of plugs, wheel chocks, safety ribbons, etc. Use of the pod during combat mission is prohibited. Payload 234 pounds; Diameter 26.5 inches; Length 183 inches

7.17 Defensive systems

The F-5E fighter is equipped with defensive systems capable of warning the pilot about radar emissions that threaten the aircraft and reducing hostile attack efficiency by dispensing flares and chaffs.

The defensive systems are:

- AN/ALE-40 countermeasures dispensing system;
- AN/ALR-87 radar warning receiver.

AN/ALE-40 Countermeasures Dispensing System

The AN/ALE-40 provides the capability of dispensing flare or chaff payloads as a means of defense against hostile radar or IR missile attack.

Number of chaff cartridges: up to 60 pcs.

Number of flare cartridges: up to 30 pcs.

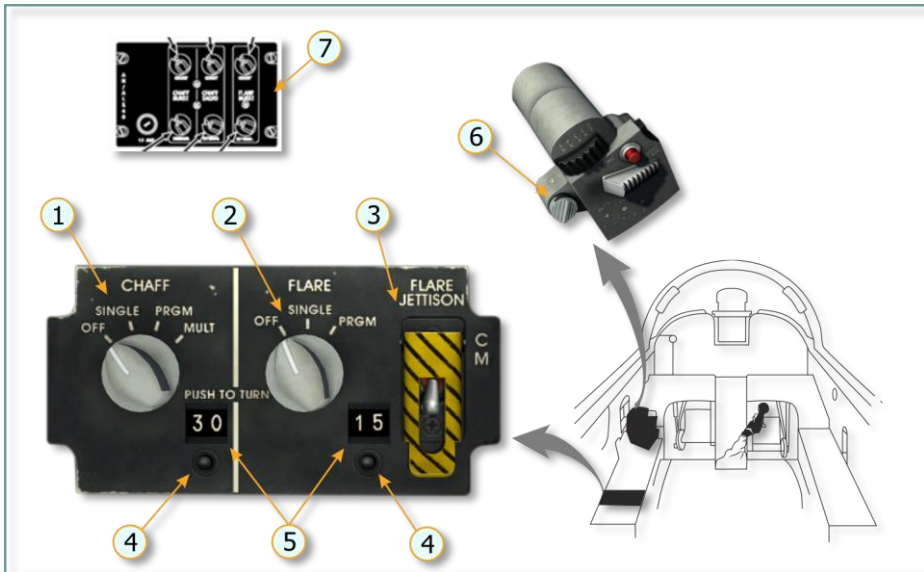

Figure 7.13 AN/ALE-40 and AN/ALR-87 Controls

No.	Element	Function
1	CHAFF Mode Selector	<p>Selects chaff dispensing mode.</p> <p>OFF – Disconnects electrical power to chaff circuits.</p> <p>SINGLE – a single chaff is dispensed when flare-chaff button is pressed.</p> <p>PRGM – chaffs are dispensed according to preset program when flare-chaff button is pressed. Program settings: 0.1, 0.2, 0.3, or 0.4-second interval between chaff bursts; 1, 2, 3, 4, 5, or 8-second interval between salvo; 1, 2, 3, 4, 6, 8 chaff bursts at an interval; 1, 2, 4, 8, salvos in a program or till the end of chaffs.</p> <p>MULT – dispenses 1, 2, 3, 4, 6, 8 flares when flare-chaff is pressed.</p>

No.	Element	Function
2	FLARE Mode Selector	Selects flare dispensing mode. OFF – Disconnects electrical power to flare circuits. SINGLE - a single flare is dispensed when flare-chaff button is pressed. PRGM – flares are dispensed according to preset program when flare-chaff button is pressed. Program setting: 3, 4, 6, 8 or 10-second interval; 1, 2, 4, 8 flares per salvo or till the end of chaffs.
3	FLARE JETTISON Switch	UP – Dispenses all flares approximately within 4 seconds.
4	Flare-Chaff Counter Reset	Used by the loading crew to reset flare and chaff counter indication.
5	Flare/Chaff Counter	Indicates the amount of flare/chaff cartridges loaded or remaining.
6	Flare/Chaff Switch	Activates flare or chaff firing circuit.
7	Programmer Control Panel	Used to select flare and chaff dispensing programs. Programmer Control Panel. The panel is located at the left gear. Program must be set on the ground before flight.

AN/ALR-87 Radar Warning System

The radar warning system (RWS) warns about radar emissions. The antennas of the system are mounted on the aircraft fuselage.



Figure 7.14 AN/ALR-87 Antennas Arrangement

- 1. Spiral antenna (each side)
- 2. Slot antenna
- 3. Spiral antenna (each side)
- 4. Blade antenna

AN/ALR-87 controls and indicators are located on the instrument panel inside aircraft cockpit and include an operating unit (indicator control) and display unit (azimuth indicator).

DIGITAL COMBAT SIMULATOR F-5E

The operating unit contains ten light keys that are used as combined operating/display elements for selecting various operation modes of the radar warning system or various display types of the azimuth indicator.

The azimuth indicator is used to display tactical use information (emission types and sources), operational monitoring displays, and self-test messages.

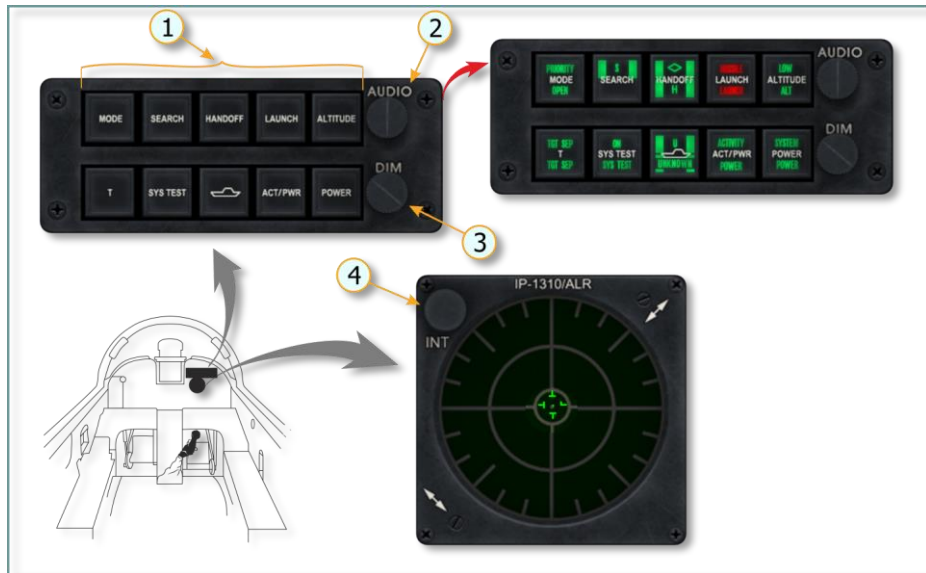

Figure 7.15 AN/ALR-87 Controls and Indicators Arrangement in Cockpit

No.	Element	Function
1.	Indicator Buttons/Lights	Selects AN/ALR-87 operation modes
2.	AUDIO Control Knob	Adjusts volume of audio warning signals
3.	DIM Control Knob	Adjusts brightness of light keys.
4.	INT (Intensity) Control Knob	Adjusts brightness of symbols on azimuth indicator.

The information on the indicator is presented as a top view with the aircraft in its center. Emitter symbols are displayed on the indicator as azimuth position relative to the aircraft. For example, if the symbol is at 9 o'clock position, the emitter is to the left of the aircraft. In addition to visual indications, the system produces audio warning signals depending on the operation mode of the detected emitter (search, tracking, and launch). Positions of emitter and launch symbols on the indicator do not necessarily correspond to the actual distance from the hostile emitter to the aircraft.

Distance from the emitter symbol to the indicator center corresponds to the emitter signal power. Generally, the closer the symbol is to the indicator center, the closer the emitter is to the aircraft.

Four bars are located on the inner circle of the indicator. Presence of these bars indicates that the indicator operates normally. In addition, the small vertical line at the left end of the 3 o'clock bar should alternate upward and downward. If the RWS is unable to identify emitters, the U symbol appears on the indicator.

The most dangerous emitters are indicated in the middle circle of the indicator. All types of the emitters indicated in the middle circle can employ weapons.

The emitter symbol marked with "diamond" indicates the most threatening weapon system, close to the aircraft.

The list of the available symbols in the simulator includes [Table 7.3](#):

- Ground-to-air radars;
- Air-to-air radars.

Table 7.3 Description and Identification of Symbols

Symbol	Identification
Ground-to-Air Radars	
A	Gepard and ZSU-23-4 Shilka self-propelled anti-aircraft guns
S6	2S6 Tunguska self-propelled anti-aircraft gun
3	S-125 Neva (SA-3) surface-to-air missile system
6	Kub (SA-6) surface-to-air missile system
8	Osa (SA-8) surface-to-air missile system
10	Acquisition radar of S-300 (SA-10) surface-to-air missile system
CS	Low-altitude acquisition radar (Clam Shell) of S-300 (SA-10) surface-to-air missile system
BB	Acquisition radar (Big Bird) of S-300 (SA-10) surface-to-air missile system
11	Acquisition radar of Buk (SA-11/17) self-propelled, medium-range surface-to-air missile systems
SD	Search radar (Snow Drift) of Buk (SA-11/17) self-propelled, medium-range surface-to-air missile systems
13	Strela-10 (SA-13) surface-to-air missile system
DE	Search radar of Sboraka mobile reconnaissance and command center (Dog Ear)
15	Tor (SA-15) surface-to-air missile system
RO	Roland surface-to-air missile system
PA	Patriot surface-to-air missile system
HA	Hawk surface-to-air missile system
S	Ground-based early warning systems

Air-to-air radars	
E3	E-3A airborne early warning and control aircraft
E2	E-2C airborne early warning and control aircraft
50	A-50U airborne early warning and control aircraft
21	MiG-21
23	MiG-23ML
25	MiG-25PD
29	MiG-29, Su-27, and Su-33
31	MiG-31
30	Su-30
34	Su-34
M2	Mirage 2000-5
F4	F-4
F5	F-5
14	F-14
15	F-15
16	F-16
18	F/A-18

The symbol has three states:

- Symbol with no circle around – indicates that the radar operates in search/acquisition mode. A warning audio signal is heard when a new emitter is detected.
- Symbol with circle around – indicates that the radar operates in acquisition/lock-on mode. If the aircraft is tracked by a surface-to-air missile system or fighter radar, the lock-on warning audio signal is generated.
- Symbol with flashing circle – indicates that hostile weapon is fired. When the guided weapon is fired, the missile launch warning audio signal is generated.

Bear in mind that the warning system does not differentiate between friendly and hostile missile launches, as well as whether the missile is air or ground launched. For this reason, warnings will be generated for friendly and ground units.

Operating Unit Key Functions (Operation modes)

Operation mode	Description
MODE	<p>Reverses display of the azimuth indicator to illustrate a maximum of 16 emitter symbols or to restrict the illustration to a maximum of 6 emitter symbols with maximum threat priority.</p> <p>Initial state: OPEN – Illustration of a maximum 16 emitter symbols.</p> <p>Alternative state: PRIORITY – Restriction to illustration to a maximum of 6 emitter symbols.</p> <p>Lower display field: OPEN – lights up if initial state was selected.</p> <p>Upper display field: PRIORITY – lights up if alternative state was selected and if no more than 6 emitters are present. PRIORITY – blinks if alternative state was selected and more than 6 emitters are present. Selection between 16 and 6 emitter symbols is made by repeatedly pressing the MODE button.</p>
SEARCH	<p>Display switchover of Azimuth Indicator for optional nondisplay/display of the emitter symbols of defined radar systems (search and monitoring radars).</p> <p>Initial state: Emitter symbols of defined radar systems are not displayed, only fire control radars.</p> <p>Alternative state: Emitter symbols of defined radar systems are displayed exclusively (no fire control radars!).</p> <p>Lower display field: Not used.</p> <p>Upper display field: Dark, if initial state selected S lights up if alternative state selected.</p>
HANDOFF	Not used
ALTITUDE	Not used
T	<p>Separates symbols that cover each other on the azimuth indicator; the symbol with the highest threat priority remains in the right place.</p> <p>Initial state: No symbol separation.</p> <p>Special state: Symbol separation effective.</p> <p>Lower display field: TGT SEP – always lights up.</p> <p>Upper display field: TGT SEP – lights up if symbol separation is effective.</p>
SYS TEST	<p>Triggers system self-test.</p> <p>Initial state: RWS operational use.</p> <p>Special state: self-test runs, duration about 10 seconds.</p> <p>Lower display field: SYS TEST – always lights up.</p> <p>Upper display field: ON – lights up in the course of self-test.</p>

Operation mode	Description
UNKNOWN SHIP	Reverses display for optional illustration/nonillustration of emitter symbols of unknown weapon systems. Normal state: Unknown emitters are illustrated with symbol U. Alternative state: Unknown emitters are not illustrated. Lower display field: UNKNOWN – always lights up. Upper display field: U – dark if initial state selected. U – lights up if alternate state selected and no unknowns present. U – blinks if alternate state selected and unknowns present.
POWER	Turns on and off the radar warning system. 1 st selection state: RWS turned off. 2 nd selection state: RWS turned on. Lower display field: POWER Upper display field: SYSTEM Note: the lower and upper displays SYSTEM + POWER always light up if radar warning system is turned on and power supply present. A 50-second self-test is performed automatically after turn-on.

Audio Warning Tones

The RWS generates warning tones in order to warn pilot acoustically.

The loudness of the audio warning tones can be adjusted by means of the AUDIO knob.

There are two types of audio warning signals:

- New emitter sound;
- Missile launch sound.

The new emitter sound consists of two equal tones within 1 second that are used for various emitter classes:

- 750 Hz – Emitter of ground/air guided weapon systems.
- 1500 Hz – Search radars and unknowns.
- 1744 Hz – Aircraft onboard radars.

The missile launch sound consists of seven tones within 1.5 seconds with a frequency of 1000 Hz.



8 NORMAL PROCEDURES

8 NORMAL PROCEDURES

Put aircraft in “cold start at the ramp” position for engines start procedure. During cold start all switches are set to required position, i.e. preflight procedures are completely fulfilled.

8.1 Engine Start

Engine start requires an external compressed air source. The compressed air spins up the compressor which provides combustion chamber with air to produce a fuel-air mixture. Ignition system may operate either from an external power source or onboard battery.

Before Start

1. Set battery switch to upper position – **BATT** (mouse button or **|RCtrl + RShift + B|**).
2. Set left and right generator switches to top position – **L GEN, R GEN** (right mouse button or left **|RCtrl + RShift + H|**; right **|RCtrl + RShift + J|**).

At the same time L GENERATOR, R GENERATOR light continues to be on.

Note: Each engine generator cuts in during starting at approximately 48 % rpm

3. Set left and right boost pump switches to top position – **LEFT, RIGHT** (mouse button or left **|RCtrl + RShift + Y|**; right **|RCtrl + RShift + I|**).



4. Connect external power source, if necessary (long wait for start clearance).
Switch on radio communication menu **| \ |**
Call ground personnel **| F8 |**
Request external power **| F2 |**
Connect **| F1 |**
5. Connect compressed air ground source
Switch on radio communication menu **| \ |**
Call ground personnel **| F8 |**
Request compressed air **| F5 |**
Connect **| F1 |**

Engine Start Sequence

The left engine is always started first. Starting the right engine requires compressed air either from an external source or from left engine compressor.

Left Engine Start

1. Give a command to supply air for engine motoring:
Switch on radio communication menu [N]
Call ground personnel [F8]
Request air supply [F5]
Supply air [F3]
2. Press left engine **START** button (2) when the speed is 10 % (1) (mouse button or [LCtrl + LShift + C]).
3. Then set left engine throttle to IDLE position (3) by pressing [RAlt + Home]

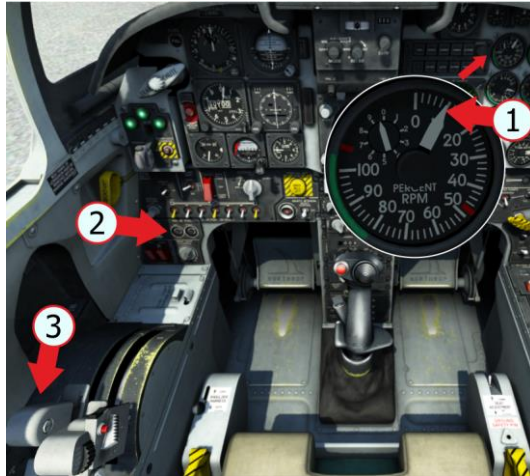

Note. Engine attains IDLE power in about 35 s

Parameters should be as follows:
 Idle speed 49 to 52 % (1);
 EGT is not less than 140°C (2);
 Nozzle position 60 to 79 % (3);
 Fuel flow rate about 400 pph (4);
 Oil pressure 5 to 20 psi (5);

Note: Overheat shall not exceed 845°C.



During starting, the **L GENERATOR** light goes off (generator is on) at 43 % engine rpm.



4. Check after engine start:
 Pressure in utility hydraulic system (UTILITY) is 2800 to 3200 psi (1);
 Aux intake door position indicator – **BARBER POLE** (left aux intake door is open, right aux intake door is closed (2) (view F2)).



Right Engine Start

Right engine start is similar to left engine start when an external compressed air source is used. Ground personnel manually switches external air source to the right engine after the left engine has accelerated to IDLE.

1. Give a command to supply air for engine motoring:
Switch on radio communication menu |\|;
Call ground personnel |F8|;
Request air supply |F5|;
Supply air |F3|;
2. Press right engine **START** button when the speed is 10 % (mouse button or |LCtrl + LShift + V|).
3. Then set right engine throttle to **IDLE** position by pressing |RShift + Home|

Note. Engine attains idle power in about 35 s

Parameters shall be as follows:

Idle speed 49 to 52 %;
Nozzle position 60 to 79 %;
Fuel flow rate about 400 pph;
Oil pressure 5 to 20 psi.

*Note: Overheat shall not exceed 845°C. During starting, the **R GENERATOR** light goes off (generator is on) at 43 % engine rpm.*

4. Check after engine start:
Aux intake door position indicator – **OPEN** (both aux intake doors are open)
5. The following ground sources have to be switched off after both engines are started.
Power (if connected):
Switch on radio communication menu |\|
Call ground personnel |F8|
Request power supply |F2|
Disconnect |F2|
- Compressed Air:
Switch on radio communication menu |\|
Call ground personnel |F8|
Request compressed air |F2|
Disconnect |F2|

Crossbleed Start

The right engine can be started with the use of compressed air from the left engine. In this case left engine speed has to be increased almost to the maximum (MIL), therefore chocks shall be placed under the wheels before engine start.

1. Give a command to install the wheel chocks before engine start
Switch on radio communication menu |\|

Call ground personnel |F8|
 Request wheel chocks |F4|
 Place them |F1|

2. Accelerate left engine to 95 % rpm (1) by pressing |RAIt + Num+|.
3. Press right engine **START** button (2).
4. When right engine is at 10 % rpm (3) set right throttle to **IDLE** position (4) pressing |RShift + Home|.

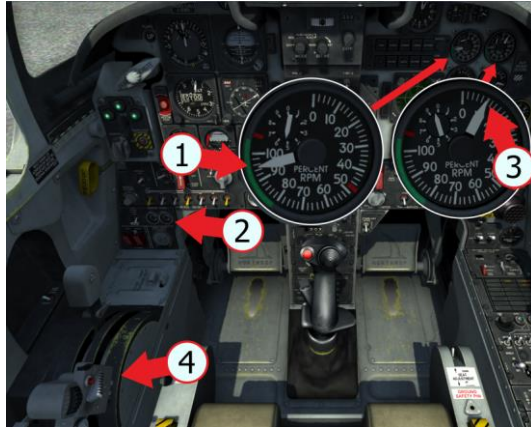

Note. Engine attains idle power in about 35 s

Parameters shall be as follows:

Idle speed 49 to 52 %;
 Nozzle position 60 to 79 %;
 Fuel flow rate about 400 pph;
 Oil pressure 5 to 20 psi.

*Note: Overheat shall not exceed 845°C. During starting, the **R GENERATOR** light goes off (generator is on) at 43 % engine rpm.*

5. After right engine is at idle rpm, retard left engine throttle to **IDLE**. Check:
 Pressure in flight control hydraulic system (FLTCONT) is 2800 to 3200 psi (1)
 Aux intake doors position indicator – **OPEN** (both aux intake doors are open) (2)



8.2 Before taxiing out

Engines are started. Critical aircraft systems need to be checked.

1. Radar mode selector to **STBY** (1) (right mouse button or **|0|**). Horizon bar shall appear on radarscope (2), radar warming will be initiated.

Warning. Radar operation time on the ground should not exceed 10 minutes due to the possibility of its overheating. If the radar operates on the ground for a long time, set radar mode selector to OFF. Set to STBY just before the takeoff.

(Clockwise rotation **|0|**; counterclockwise rotation **|9|**)

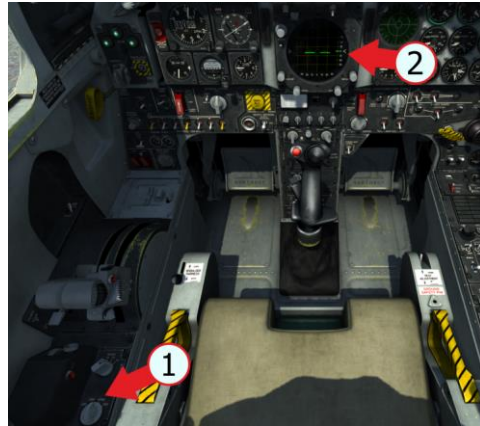

2. Set speed brake to retraction by pressing the left mouse button or press **|LCtrl + B|** and check speed brake retraction **|F2|**, which is evidenced by slight horizontal tail deflection upwards.



3. Set flap thumb switch to **AUTO** position pressing twice the left mouse button or press **|F|**. Visually check full flap extension and horizontal tail deflection downwards **|F2|**



- Switch on pitch and yaw dampers by setting damper switches to PITCH (1) and YAW (2) position pressing the left mouse button or press (PITCH |LAlt + LCtrl + W|; YAW |LAlt + LCtrl + E|).



- Check operation of pitch damper cutoff device. Press the pitch damper cutoff switch on the control stick (1) (pressing the left mouse button or press |A|), and set the pitch damper switch to OFF position (2). At the moment of switching off, some horizontal tail movement (up-down) can be seen (F2). Upon completion of the check, switch on the pitch damper by placing the pitch damper switch to PITCH.



- Set pitch trim to takeoff position (2) pressing the left mouse button (1) or press |RCtrl + .| depending on take off aircraft configuration: presence/absence of pylons, stores, rockets in launchers, and guns ammo [Table 8.1](#)



Note: Trim display is in a hard-to-see place. In order to facilitate the process, switch on aircraft controls position indicator by pressing |RCtrl + Enter| and determine trim position against the maximum pitch trim mark on the trim line (by 10 points)

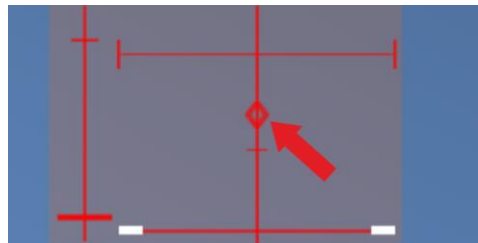

Warning. The trim not set to takeoff position may result in considerable pitching moment after liftoff which can lead to aircraft crashing, especially with high takeoff weight.

Table 8.1 Pitch Trim for Takeoff

Approximate takeoff configuration	Aircraft center-of-gravity position, % MAC	Indicated pitch trim position
Without gun ammo, without stores	18 and more	6
Fuel tanks, ammo, missiles	14 to 18	7
Fuel tanks, ammo, missiles, bombs, rockets	10 to 13	8
Gun ammo, missiles, bombs, rockets, containers	10 and less	9

System Check continued

7. Altimeter check.
Set current pressure (altitude at 0)
Set mode control lever (0.5 s) to **PNEU** position – **PNEU** light is on
set mode lever (0.5 s) to **ELECT** position – **PNEU** light is off.

Note: When changing modes, altitude values shall not differ more than 75 feet.



8. Push pitch trim knob on standby attitude indicator (actuate it). Set pitch to minus 3° on the gyro horizon.

Note: In order to unlock the knob in pulled position, turn it using the mouse wheel.



9. After system check before taxiing, give command to remove wheel chocks (if placed):
Switch on radio communication menu | \ |
Call ground personnel | F8 |
Request wheel chocks | F4 |
Remove wheel chocks | F2 |

8.3 Taxiing

Make sure that wheel chocks are removed (external view | F2 |)

In order to move off from the rest position, advance engine throttle up to 65 - 70 %. Push nosewheel steering button [S] and deflect the pedal to steer the aircraft. Steering direction is kept by nose wheel steering mechanism and can be adjusted by deflecting respective pedal.

Note: Taxiing speed shall be controlled by means of the throttles and main wheel brakes [W] so as to avoid aircraft roll-over during its steering. Engines shall be approximately at 57 % rpm during taxiing.

8.4 Before takeoff

1. Set nose strut switch to EXTEND (hiked position) (mouse button or [LAlt + LCtrl + Q]). Pitch attitude(AOA) will increase by 3°

Note: With nose strut dehiked, liftoff speed and distance are increased by approximately 20 % and 45 % accordingly.



2. Sight mode selector – as required by mission.



3. Radar mode selector – as required by mission.



4. Check flight and navigation instruments. (pitch – 0, heading – takeoff, altitude – 0)



5. PITOT HEAT switch (1) - ON (mouse button or **|RCtrl + RShift + F|**) and, if necessary, ENGINE ANTI-ICE switch (2) – ON (mouse button or **|RCtrl + RShift + G|**)

NOTE. Enabling engine heat slightly reduces engine thrust. Turn on heating if necessary when the outdoor temperature is below 4°C and humidity is high.

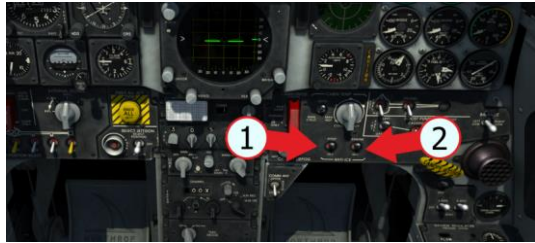

6. Close cockpit canopy (1) (mouse button or **|LCtrl + C|**). Caution light goes off (2).



7. Check MASTER CAUTION light (1) and caution lights (2) – must be off.



8.5 Takeoff

1. Apply main wheel brakes |W|
2. Advance engine throttles to MIL |Num+|. Check parameters (engine rpm 101 ± 2 %; acceleration time (acceleration within 7 seconds, stabilized within 10 seconds), the temperature 665-675 °C; nozzle position of 0-16 %).
3. Release brakes, start takeoff run.
4. Advance throttles to MAX |Num+| (afterburner switches on within approximately 5 seconds)
5. During the first half of the run, keep the direction by steering the nose wheel (using |S| and |X| or |Z|), after 60 KIAS use only rudder (|X| or |Z|) to keep the direction.
6. Approximately 10 KIAS before liftoff speed, smoothly pull the control lever to lift the nose wheel up and set the aircraft to take takeoff attitude. Ideally, the stick should be fully pulled aft at the moment of aircraft lift off.

The [Table 8.2](#) below shows correlation between liftoff speeds and takeoff weight, provided control stick is fully pulled aft.

Table 8.2 Takeoff performance

Takeoff weight, 1000 lb	Stores, ammo	Center-of-gravity position, % MAC	Liftoff speed, KIAS
15000	none	18 to 17	143 to 145
15500 to 16000	Gun ammo, missiles	14 to 13	153 to 155
17000 to 18000	Central fuel tank, gun ammo, missiles	12 to 11	164 to 168
19000	3xFuel tanks 150, gun ammo, missiles	15 to 14	166 to 168
19000 to 21000	Bombs, rockets, Central fuel tank, gun ammo, missiles	15 to 14	168 to 175
19000 to 21000	Bombs, rockets, center fuel pods, gun ammo, missiles	15 to 13	168 to 175
22000	3xFuel tanks 275, gun ammo, missiles	15 to 13	178 to 180

23000 and more	Bombs, rockets, gun ammo, missiles	15 to 14	185 to 190
----------------	---------------------------------------	----------	------------

Note. If gun ammo is removed, at any given armament configuration the liftoff speed decreases by appr. 10 knots due to center-of-gravity shift forward by 5 % MAC (Mean Aerodynamic Chorde)

7. Upon liftoff ensure positive climb rate is achieved by maintaining angle of attack so that airspeed and altitude keep increasing.
8. Set landing gear lever to up position |G|. Check landing gear position indicator lights are off.
9. Set pitch trim as required.
10. Set flaps position as required.
11. Check indicator to make sure that aux intake doors are closed.

8.6 Climb

It is recommended to climb at speed not less than 300 KIAS.

1. Check EXT FUEL transfer switches position (if external tanks installed) or AUTOBALANCE switch.
2. At altitude above 8000 feet check indicated oxygen consumption.
3. Check cockpit pressurization.
4. Set altimeter mode (as required).

Autobalance

Balancing is the procedure of leveling remaining fuel between left and right fuel systems. (left engine cell is in front, and right engine tanks are in the fuselage aft section). Right engine fuel system contains approx. 550 pounds (85 gallons) of fuel more than left engine fuel system. The two systems should be balanced as soon after takeoff as possible to prevent aft CG shift, which leads to maneuverability degradation, especially during landing approach.

Auto Balance Switch — **LEFT LOW** after fuel in external tanks is depleted.

Autobalance is started when the remaining fuel is between 4040 – 3500 pounds and is carried out until the fuel is completely depleted.

The fuel quantity indicator should be monitored to maintain the two systems within 200 pounds of each other to ensure that CG remains within limits.

Manual Balancing

1. CROSSFEED switch – ON (mouse button or |RCtrl + RShift + U|).
2. Switch off fuel boost pump (LEFT or RIGHT) on low fuel side.
3. When indicated fuel level in left and right engine fuel systems is equal, switch on the booster pump which was switched off.
4. CROSSFEED switch – OFF.

8.7 Landing

Landing is the most hard and dangerous element of flight. It includes the following elements:

- Pilot actions before landing;
- Landing approach and pre-landing descent (on a glide slope);
- Landing and ground run for deceleration.

Successful landing depends on strict observance of all required actions and capability to maintain specified conditions.

Typical mistakes that can be made during landing:

Table 8.3 Dangers during landing

No.	Dangers	Consequences
1.	Failure to extend flaps	Keeping the predetermined speed on descent glide slope without flaps extension can lead to high angles of attack, loss of speed and stalling.
2.	Failure to extend LG	Landing without LG leads to an accident and aircraft crash
3.	Failure to follow the glide slope	Crosswind or carelessness of a pilot at glide slope can lead to miss of a runway resulting in accident and aircraft crash
4.	Exceed of predetermined speed on glide slope	Landing at increased speed can lead to rough landing, repetitive airplane liftoff with consequent crash situation development and aircraft crash.

No.	Dangers	Consequences
5.	Landing approach at a speed below predetermined one	Landing approach at speed less than predetermined speed, can lead to stalling on glide slope, landing before a runway or hard landing resulting in aircraft crash.

Before Landing

1. When landing not at a takeoff airfield, the airfield pressure should be set on the altimeter.
2. Stop fuel balancing operation (if on) by setting CROSSFEED switch to **OFF** (mouse button or |RCtrl + RShift + U|).
3. Check that hydraulic system pressure is within 2800 to 3200 psi.
4. Decrease flight speed up to 300 KIAS and check engine aux intake door position at altitude less than 3000 ft – OPEN.

Landing approach and landing

The typical landing approach is shown in this scheme below. Landing weight is 11700 lb (remaining fuel 1000 lb), without gun ammo.

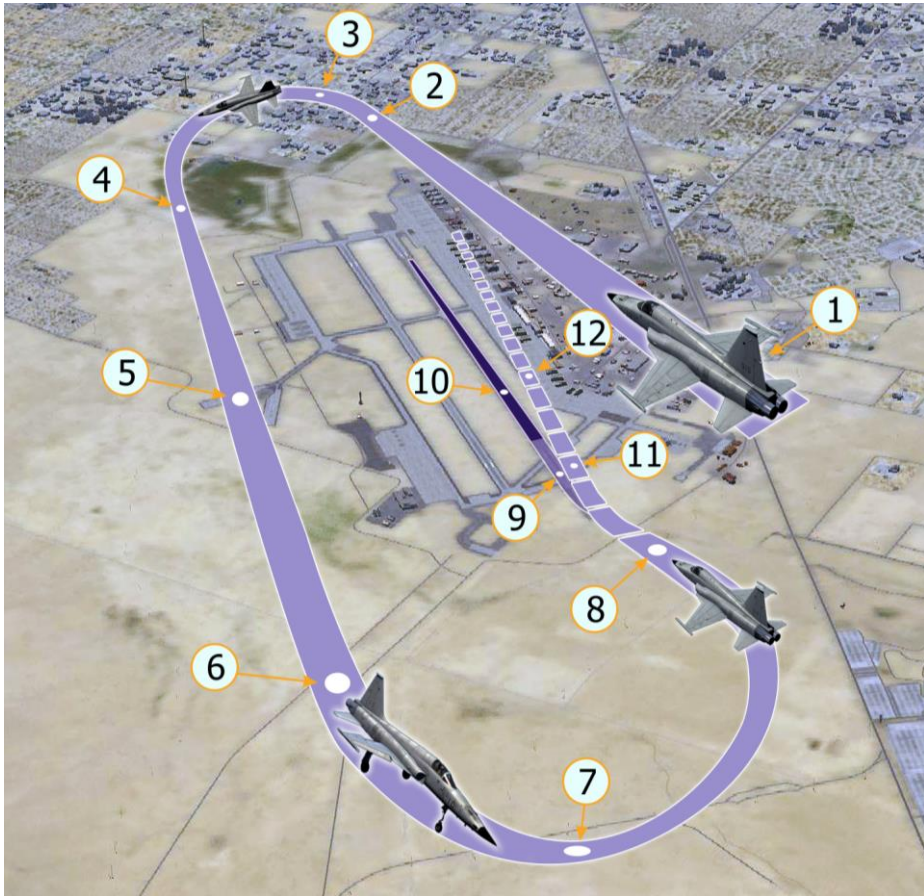

Figure. Landing Pattern

1. Set speed to 300 KIAS and get to altitude of 1500 feet 3 miles before runway leading edge. Set a predetermined course corresponding a landing course on the horizontal situation indicator.
2. Having flown above a runway with landing course at altitude of 1500 feet, start turning to the reverse landing course at speed of 300 KIAS keeping the altitude of 1500 feet
3. Set flap thumb switch on right engine throttle to **AUTO** position (press **|F|**). At the same time flap lever has to be set to **THUMB SW** position (center position). Set throttles so as to ensure decrease to 260 KIAS.
4. Extend gear. Gear lever to LG DOWN position (press **|G|**)
5. Check green lights illumination indicating the landing is on downlock.
6. Retard throttles to decelerate to 165 knots and keep the altitude of 1500 feet. Use speed brakes if necessary by setting speed brake switch located on throttle to **OUTER** position (press **|LShift + B|**). Control wing flap extension with help of **FULL** indicator and visually.

7. Carry out turning to the landing course at the altitude of 1500 feet and at 165 KIAS.
8. After turning to landing course, begin descent at speed of 1000 feet/min. Decrease engine speed so that the speed is 145 KIAS. At the same time angle-of-attack indicator has to be within 3 o'clock mark and green symbol (circle) on angle-of-attack indicator illuminated.

ATTENTION. Always control the direction to a runway (it's necessary to descend strictly in line with a runway), direction deflection has to be corrected immediately by course correction. Descend to the beginning of a runway.

9. When approaching the beginning of a runway, vertical speed decreases to 400 feet/min. At the flare altitude (approximately 20 feet) perform flare by pulling control lever so that the aircraft is above a runway at the altitude of 2 to 3 feet without vertical speed. Smoothly decrease speed to idle and at runway approach, take landing attitude necessary for soft landing on two main wheels at speed of 135 KIAS.
10. Smoothly lower the nose wheel, apply drag chute (press [P]). Begin braking procedure depending on runway length left. Antiskid device is not installed in the aircraft and in case of skid, release brakes, align the aircraft and then continue braking.
11. If proceeding to go-around, increase the speed to maximum (afterburner). If the speed is more than 160 KIAS stop descending.
12. Retract landing gear. Gear lever to upper position (press [G]). If the speed continues to increase, begin climbing.

WARNING! If the remaining fuel level is more than 1000 pounds, add 1 KIAS per each 200 pounds. If the guns are fully loaded, increase the speed by 5 KIAS.

Formula to calculate runway approach speed depending on weight and ammo:

$\text{Vapproach} = 145 + 5(\text{if there is gun ammo}) + (\text{fuel remaining} - 1000) / 200$

EXAMPLE. If there are full gun ammo and fuel level of 3000 pounds, increase the speed by 15 KIAS. I.e. Speed before turning to landing course has to be 180 KIAS. Glide path speed has to be 160 KIAS.

After landing

1. Drag Chute — Jettison (mouse button or [P])
2. Cockpit Pressurization Switch — RAM DUMP (prior to opening canopy) (lift the protective cover [RCtrl + RShift + Q] and switch up [RCtrl + RShift + A]).
3. Flap Thumb Switch — UP [LShift + F].
4. Speed Brake - Out (if was in) [LShift + B].
5. Radar Mode Selector — OFF [9].
6. Optical Sight Mode Selector — OFF [`].
7. Pitot Heat and Engine Anti-Ice Switches — OFF.

Engine shutdown

1. Cockpit Pressurization Switch - RAM DUMP.
2. Canopy — Open [LCtrl + C].

CAUTION. The canopy seals remain inflated if engines are shut down with canopy locked. Attempts to open canopy with seals inflated may result in damage to canopy drive mechanism.

3. Cockpit Pressurization Switch - NORMAL/CABIN PRESS.
4. All Unguarded Switches (except battery, generators, and fuel boost pumps) – OFF.
5. Throttles - OFF.
6. Standby Attitude Indicator - Caged and Locked.
7. Battery Switch – OFF. Left |RAIt + End|; right |RShift + End|.



9 AIRCRAFT AERODYNAMIC PARTICULARS

9 AIRCRAFT AERODYNAMIC PARTICULARS

Unlike earlier modifications F-5E-3 is equipped with automatic maneuver flaps control system providing optimal wing leading and trailing edge flaps operation depending on airspeed and AOA. This system, as well as improved "Shark Nose" forebody design and increased-area wing leading-edge extensions (LEX), allow pilot to efficiently utilize the aircraft extraordinary maneuvering performance by facilitating its control, improving its stability at high AOA and reducing stall speed.

9.1 Maneuverability

F-5E-3 is a high-performance multipurpose tactical fighter with a primary mission of air superiority. It is equipped with wing leading and trailing edge flaps, which provide increased lift and improved maneuvering performance. However, during acceleration flaps are retracted in order to reduce drag and to provide better acceleration.

Pitch and yaw stability augmenting and damping system provides improved characteristics and more fluent control of the airplane.

At the airspeeds above 360 KIAS the airplane is able to reach structural limiting normal load while below 360 KIAS attainable g's are limited by the stall AOA. For the F-5E-3 with shark-nose forebody and increased-area LEX wing stall occurs at approximately 27-28 units AOA and is accompanied by the wing-rock or by the wing-drop depending on flight conditions and configuration.

At lower airspeeds airplane maneuvering performance rapidly degrades so it is recommended not to let the airspeed fall below 300 KIAS while maneuvering. This requirement can be neglected during maximum range gliding, landing approaches and when performing tactical maneuvers which involve flying at low airspeeds/high AOA.

9.2 Control effectiveness

Pitch

All-moving stabilizer provides satisfactory pitch control of the aircraft above 100 KIAS, at the airspeeds below this level control effectiveness rapidly

degrades. At high Mach numbers, particularly at 0.9–0.95 for clean aircraft or near limiting Mach numbers for aircraft with stores pitch control sensitivity increases. This may cause g overshoots beyond structural limits and problems with trimming the aircraft.

WARNING! Due to increased pitch sensitivity abrupt aft stick inputs may cause AOA overshoots beyond stall, which may lead to PSG or spin entry.

NOTE. Pitch control effectiveness provides pitch change rate of about 8 degrees per second in case of rapid stick input. However, pitch change rate generated by abrupt stick input is much greater.

Application of speed brakes may cause nose-up or nose-down pitch trim changes, depending on airspeed and altitude.

Roll/Yaw

Ailerons provide effective roll control up to approximately 20 units AOA. At Mach numbers of 0.8–0.95 lateral stick input to the spring stop produces high roll rates leading to significant g increase due to roll coupling.

Above 20 units AOA rolling effectiveness of ailerons rapidly degrades due to wing stall as well as to adverse sideslip generated by aileron deflection. The latter can be reduced by proper blend of rudder with ailerons for roll control of the aircraft at AOA greater than 20 units.

Rudder rolling effectiveness remains high throughout the whole flight envelope except for the AOA above stall where roll and yaw hesitations develop. At or near zero g rudder doesn't roll the aircraft while at negative g's rolling direction is opposite to the rudder input.

Application of rudder at high AOA generates additional yaw rate which can couple with roll rate thus producing significant AOA increase. For this reason, aggressive rudder rolls performed with partial or full sustained rudder may cause AOA overshoot above stall AOA. When accompanied by a nose-up pitch command aggressive rudder rolls may drive AOA well above stall.

WARNING! Abrupt aft stick input during aggressive or sustained rudder rolls may result in PSG or spin entry.

NOTE. A large rudder roll rate may mask rapidly increasing yaw rate.

Roll entry G

Aforementioned increase of AOA due to roll-yaw coupling exhibited in rolling maneuvers results in an increase in load factor. For this reason, roll entry g is

established at which a maximum rate 360-degree rolling maneuver can be initiated without exceeding maximum allowed load factor. For example, an airplane with an empty centerline tank entering a sustained 360-degree roll at the maximum rate (lateral stick to the spring stop) with the load factor of 4.8 will not exceed 6 g unless aft stick is applied. In general roll entry g depends on the aircraft configuration.

Exceeding the aileron spring stop at roll entry g results in significant normal load increase beyond the maximum allowed g limit.

High pitch attitude/low airspeed flight

Recovery of the aircraft to the level flight at pitch attitude below 75 degrees and low airspeed doesn't typically require any control inputs. The aircraft tends to pitch toward the horizon at approximately zero g until flying speed is regained. If forward stick is applied during recovery inverted PSG or inverted spin entry is possible.

For the recovery from the pitch attitude exceeding 75 degrees it is recommended to perform coordinated roll to the nearest horizon and then maintain aft stick along with preventing any sideslip until the aircraft pitches below the horizon. When flying speed is regained recovery from the inverted flight can be performed.

If the airspeed falls below 100 KIAS stabilizer effectiveness is no longer sufficient to reduce AOA and to control the aircraft recovery. In this case recovery may occur in different ways with the aircraft typically performing a tailslide maneuver and ending up in inverted flight. For this reason, rolling/yawing motions, sideslip or abrupt lateral/directional control inputs may result in inverted PSG or inverted spin entry.

WARNING! If the airspeed falls below 100 KIAS at pitch attitude greater than 75 degrees controlled recovery will not be possible due to insufficient pitch control effectiveness. Inverted PSG or inverted spin entry is also highly probable.

9.3 Stalls/spins

Typically, clean aircraft stalls at approximately 28 units AOA but due to high level of the aircraft's inherent lateral-directional stability and spin-resistance departure from controlled flight at high AOA rarely occurs, especially with maneuver flaps set to AUTO. 1g stalls typically occur after the airspeed drains below certain level during flight with sustained full aft stick.

Stalls

First indication of the forthcoming stall is the onset of light-intensity buffet occurring at 16 17 units AOA with maneuver flaps set to AUTO and at 13 14 units AOA with flaps up. As AOA increases towards stall buffet gradually becomes more pronounced.

1g stall typically occurs at 27 28 units AOA. With AUTO flaps it is followed by onset of the wing rock while with flaps up 1 g stall results in nose slice accompanied by the wing drop then progressing to the wing rock. If full aft stick is held, the wing rock may become more intense resulting in AOA exceeding 30 units.

Accelerated stalls are usually characterized by nose slice and the wing rock resulting in problems with maintaining g-level and the aircraft being rolled out of turn.

Stall recovery

The aircraft typically recovers from stall and returns to a controlled flight soon after relaxing aft stick pressure, so that AOA is reduced below stall thus terminating the wing rock.

PSG

In some cases, AOA may significantly increase so that it exceeds typical stall values of 28 30 units. This situation may take place when full aft stick is held near stall thus leading to an intense wing rock accompanied by AOA overshoots due to the roll coupling. AOA may also increase beyond 30 units during sustained rudder rolls with roll entry g exceeding recommended level. Possibility of reaching AOA above stall is further increased if abrupt aft stick is applied during an aggressive rudder roll.

Exceeding 30 units AOA is most probable within the airspeed range between 190 and 250 KIAS. At the airspeed higher than 250 KIAS inherent aerodynamic stability prevents the airplane to reach high AOA while at the airspeed below 190 KIAS control effectiveness is too low to generate sufficient pitch rate.

As 30 units AOA is reached it is highly probable that the airplane enters a Post-Stall Gyration (PSG) – an uncontrolled oscillatory motions about all three axes. Airspeed during the PSG rarely exceeds 110 KIAS. It is important that simply releasing aft stick pressure doesn't result in immediate reduction of

AOA and recovery to controlled flight. Recovery from the PSG requires slight forward stick pressure with rudder and ailerons neutral. The airplane typically recovers as soon as airspeed reaches 130 KIAS.

Delayed or improper recovery procedure (such as abrupt rudder inputs) may result in the PSG transitioning to a spin. Excessive forward stick pressure during the PSG recovery may result in an inverted spin entry.

Spins

As it was mentioned above, if a PSG recovery is delayed yaw rate may increase and the airplane may enter a spin. At the first moments the spin is usually oscillatory but then it may develop into a flat spin.

Oscillatory spin is characterized by significant pitching, yawing and rolling oscillatory motions with the average pitch attitude being 30 degrees below the horizon. In the flat spin pitch attitude is normally slightly above or on the horizon with rolling and yawing motions being less intense.

Altitude loss is approximately 1700 to 2500 feet per turn in the oscillatory spin and 1500 feet per turn in the flat spin.

Recovery from the oscillatory spin is possible but is highly unlikely from the flat spin.

Recommended spin recovery procedure:

- Determine direction of the spin;
- Apply full forward stick and full pro-spin lateral stick (exceed the spring stop if necessary) press and hold **|L|**;
- Apply full opposite rudder;
- Switch maneuver flaps to AUTO press **|F|**;
- Neutralize controls as the airplane stops rotating;
- The airplane recovers to controlled flight as the airspeed reaches 130 knots.

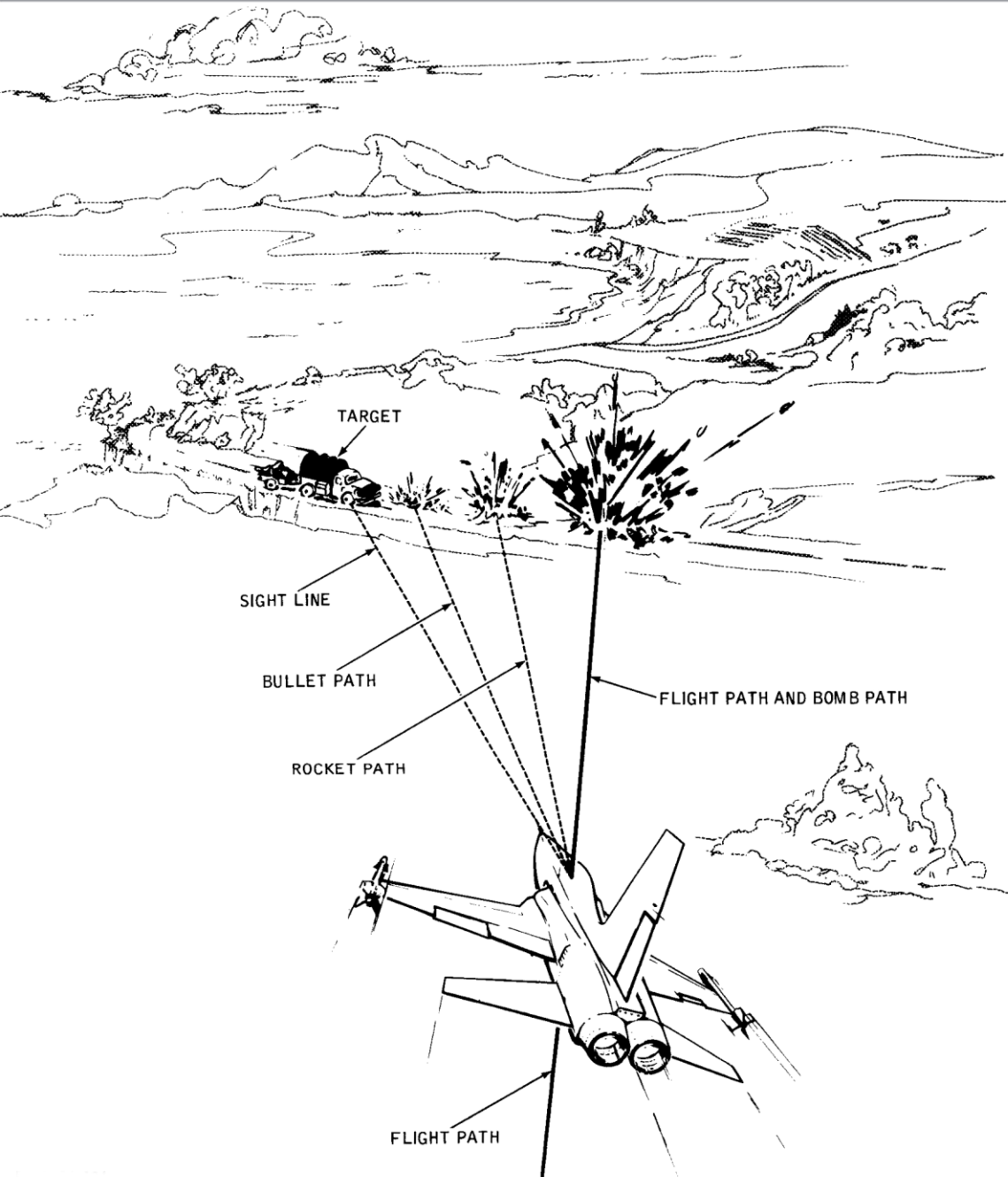

10 COMBAT EMPLOYMENT

10 COMBAT EMPLOYMENT

10.1 Air-to-air combat employment

JOINT OPERATION OF RADAR AND SIGHT SYSTEM DURING AIR-TO-AIR COMBAT

MSL Mode

Target search:

1. Set radar mode selector to OPER position (1) (right mouse button or |0|).
2. Set the RANGE selector to 40 (2) (right mouse button or |-|).
3. Set GUNS/MISSILE and CAMERA switch to top position (3) (right mouse button or |LCtrl + LShift + G|).
4. Turn on position selector switches of wingtip launchers with AIM-9 missiles on armament control panel (4) (mouse button or |LCtrl + LShift + 1| – left wingtip; |LCtrl + LShift + 7| – right wingtip.)

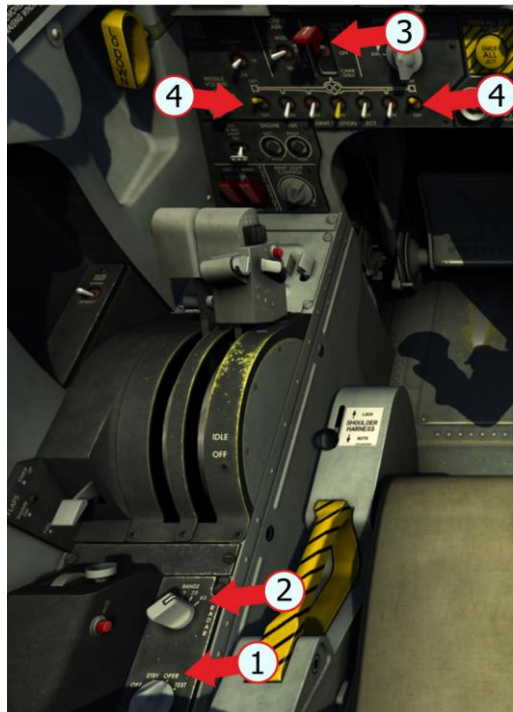

5. Select MSL mode [1].



6. Use ELEV lever to watch upper and lower hemisphere
[RShift +] – Radar dish up;
[RShift +] – Radar dish down.



7. Target symbol appears on radarscope after target acquisition, continue approach to target up to 20-mile range.

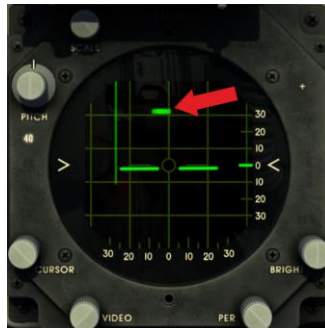

8. Set RANGE selector to 20 |←|.



9. Target acquisition symbol appears, continue approach to target up to 10-mile range.



Target lock-on and tracking:

1. When 10-mile range is reached, align acquisition symbol with target using TDC button (1) (|↑| – up, |←| – left, |↓| – down, |→| – right), and push ACQ button (2) [|Enter|](#) to lock on the target, at the same time radar display scale is automatically changed to 10 miles.

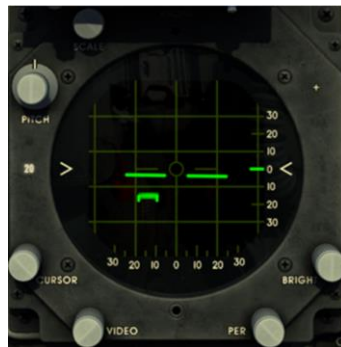
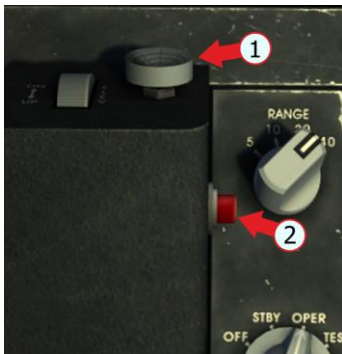

2. After the target is locked on, the following is shown on the radar indicator:
 LK ON light (1);
 Aim symbol (2);
 Radar beam is shifted to the left to facilitate the use of targeting information;
 Range gate on target (3);
 Sight pipper shows radar antenna position.

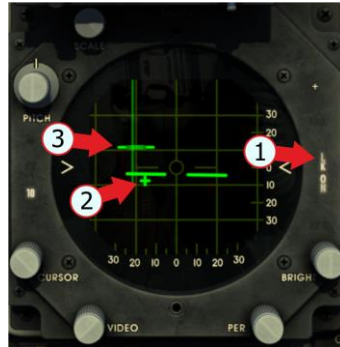

3. Maneuver the aircraft to align radarscope center circle with the aim symbol and continue approach keeping aim symbol inside center circle.

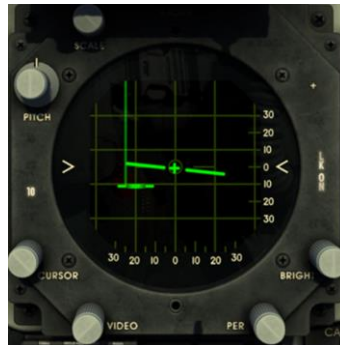

Target attack:

1. IN RANGE light comes on and the targeting information is displayed on optical sight when aircraft reaches launch range.

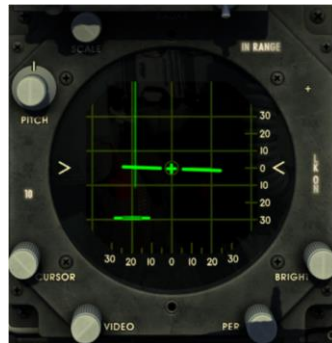

2. Continue target approach until seeker lock-on audio tone is heard. Press and hold MISSILE UNCAGE switch |RShift + M| after seeker lock-on to facilitate maneuvering to advantageous attack position.



3. After attack position is taken, push BOMB-ROCKET button to initiate launch |RAlt + Space|.

In MSL mode, the radar stores target parameters for 1.75 s after target lock-on is lost. The radar continues to track the target if it appears within 1.75 s.

If target does not appear, radar initiates search phase.

Radar antenna returns to the position held during previous search phase. Acquisition symbol appears in last target position before lock-on was lost.

Perform target acquisition and lock-on once again.

If it is necessary to break lock-on, push ACQ button |Enter|

Radar initiates target acquisition;
Acquisition symbol reappears at the last range and azimuth position before lock-on was broken.

In order to go back to target search phase, push DOGFIGHT/RESUME SEARCH switch on the aircraft control stick |R|. Radar antenna will initiate target search.

Dogfight Missile (DM) Mode

Target search:

1. Set radar mode selector to OPER position |0|.
2. Set RANGE selector to 20 |-|.
3. Set GUNS/MISSILE and CAMERA switch to top position |LCtrl + LShift + G|.
4. Turn on position selector switches of wingtip launchers with AIM-9 missiles on armament control panel |LCtrl + LShift + 1| – left wingtip; |LCtrl + LShift + 7| – right wingtip.

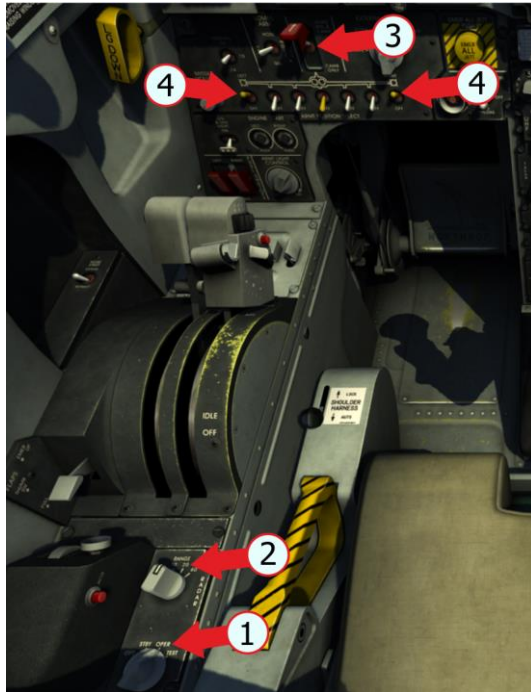

5. Turn on optical sight in any of the modes for display sight reticle |1|.



6. After target symbol appears on radarscope, maneuver the aircraft to align target to 0° azimuth and elevation and continue approach to target up to 10-mile range.

If the target and fighter are at the same altitude, a banked turn is sufficient to place the target symbol along the Central vertical line of the radar indicator. It will correspond to 0° in azimuth (1). Maintaining flight altitude equal to the height of the target will correspond to 0° in elevation (2).

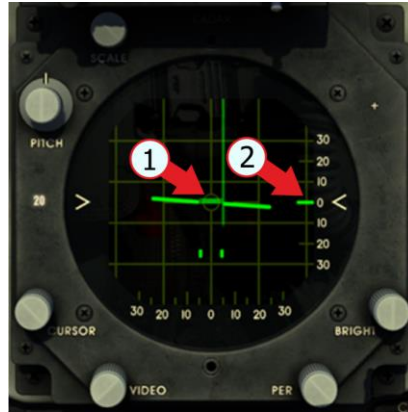
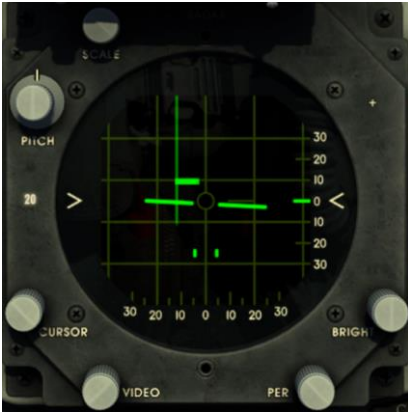

7. Continue to approach the target up to 30,000 feet (4,9 miles), maneuver the aircraft to keep the target symbol at zero azimuth and to maintain level flight. Target symbol will move down as range decreases..

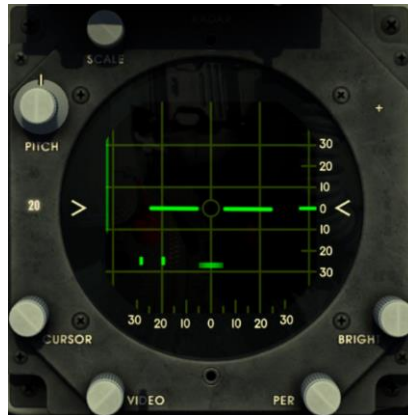

8. Upon reaching the target range 30,000 ft select DM mode with a quick tap of the Dogfight/Resume Search switch in forward position [5].

If the target is above (below), maneuver to achieve target position corresponding to the azimuth 0, and continue approach to the range of 30,000 feet (4.9 nautical miles). Target symbol will move down as range decreases.

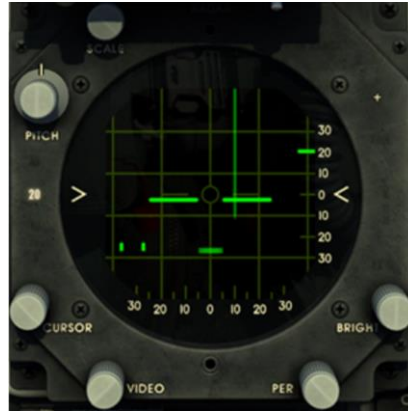
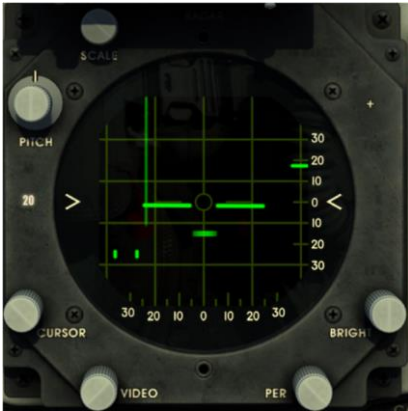

Upon reaching distance of 30,000 feet, start to climb (descend) with an angle equal to the antenna elevation angle, thereby achieve target position 0 in elevation (altitude).

Select DM mode with a quick tap of the Dogfight/Resume Search switch in forward position |5|.

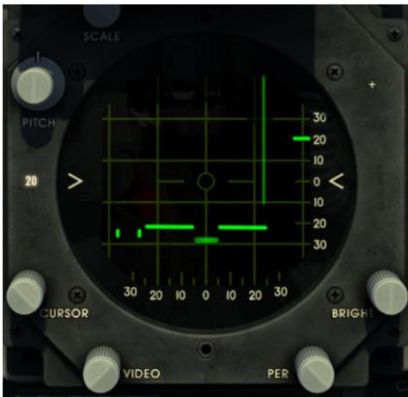

Target lock-on and tracking:

1. After DM mode is selected, target lock-on and tracking is started automatically, at the same time radarscope scale changes to 10-mile range. Continue approach to the target up to 30,000 ft range.

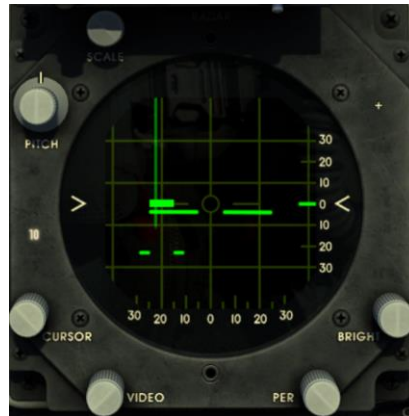

2. If target is between 500 and 30 000 ft range, radar locks on to target automatically.

After target is locked on:

LK ON light comes on.

Aim symbol appears on the radar display.

Targeting information is shown on reticle.

3. Maneuver the aircraft to align radarscope center circle with aim symbol and continue approach to the target.

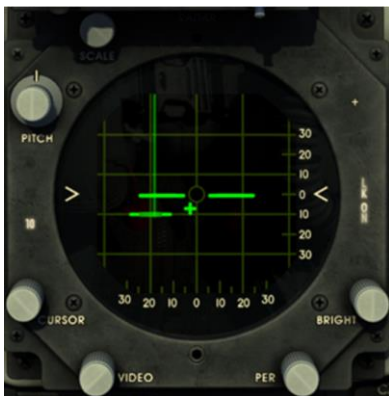

Target attack:

1. After visual contact with target, maneuver the aircraft to align reticle pipper with target.
2. IN RANGE light comes on (1) and in-range marker is displayed (2) on optical sight when aircraft reaches launch range.

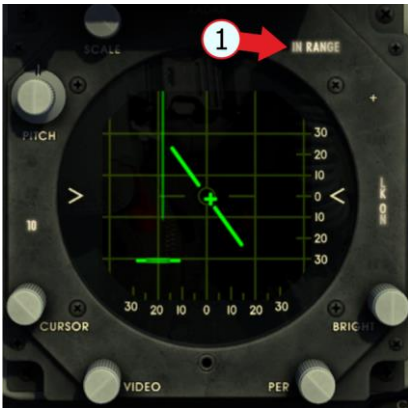

3. Continue the target approach until seeker lock-on audio tone is heard. Push and hold **MISSILE UNCAGE** switch [RShift + M] after seeker lock-on to facilitate maneuvering to advantageous attack position. After the position is taken, push **BOMB-ROCKET** button to initiate launch [RAlt + Space].



WARNING: When launching a missile, the excess-G marker shall not be displayed on the optical sight.

Dogfight Gun(DG) Mode

Target search:

1. Set radar mode selector to OPER position (1) |0|.
2. Set RANGE selector to 20 (2) |1|.
3. Set GUNS/MISSILE and CAMERA switch to top position (3) |LCtrl + LShift + G|.



4. Turn on optical sight in any of the modes for display sight reticle |1|.



5. After target symbol appears on radarscope, maneuver the aircraft to center target on 0° azimuth and slightly below ARL. Continue approach to the target up to 5-mile range.

If the target and fighter are at the same altitude, a banked turn is sufficient to place the target symbol along the Central vertical line of the radar indicator. It will correspond to 0° in azimuth. Maintaining flight altitude equal to the height of the target will correspond to 0° in elevation.

Continue to approach the target up to 5,600 feet, maneuver the aircraft to keep the target symbol at zero azimuth and to maintain level flight. With decreasing range target symbol will move down.

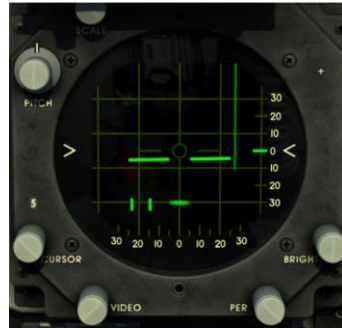
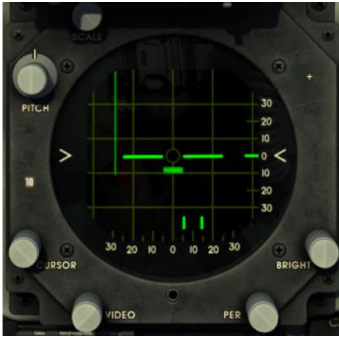

After visual target detection select DG mode with a quick tap of the Dogfight/Resume Search switch in aft position [6].

If the target is above (below), maneuver to achieve target position corresponding to the azimuth 0° , and continue approach to the range of 5,600 feet. After a visual target detection select DG mode and maneuver to put the target into radar cone of detection.

Target lock-on and tracking:

1. After DG mode is selected, target lock-on and tracking is started automatically, at the same time radarscope scale changes to 5-mile range. Continue approach to the target up to 5,600 ft range.

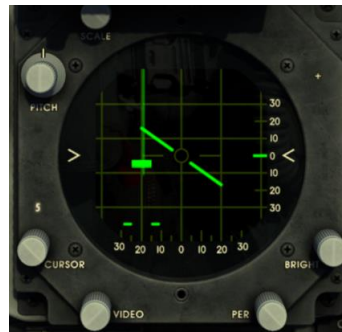

2. If target is between 500 and 5600 ft range, radar locks on to target automatically.

After target is locked on:

LK ON light comes on;
Targeting information is shown on reticle.



Target attack:

1. The task is to project target and pipper motion to a point of intersection and to fire approximately one projectile time-of-flight before intersection would occur. IN RANGE light comes on and in-range marker is displayed on optical sight when aircraft reaches launch range of 2700 ft. Trigger - Squeeze (Second Detent) |Space|.

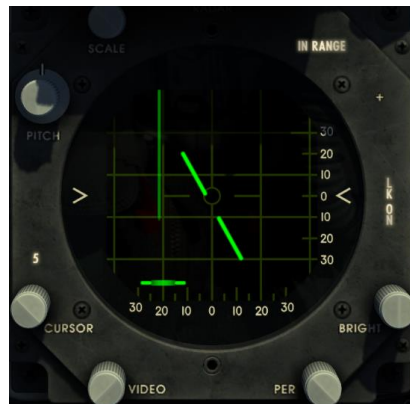



GUN A/A1 and A/A2 GUNS MODES

A/A1 GUNS MODE

A / A1 GUNS mode is same as Dogfight Guns (DG) mode.

1. The mode is selected by setting the switch to A/A1 position on the AN/ASG-31 control panel [2].



2. Push ACQ button to lock on to the target |Enter|, at the same time radarscope scale changes to 5-mile range.



A/A2 GUNS mode

Target search:

1. Set radar mode selector to OPER position |0|.
2. Set RANGE selector to 20 (2) |1|.
3. Set GUNS/MISSILE and CAMERA switch to top position |LCtrl + LShift + G|.



4. After target symbol appears on radarscope, maneuver the aircraft to center target on 0° azimuth and slightly below ARL. Continue approach to the target up to 5-mile range.

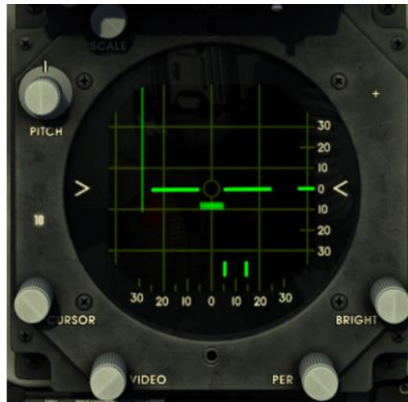

5. Set selector to A/A2 position on AN/ASG-31 control panel [3].



Target lock-on and tracking:

1. Push ACQ button [\[Enter\]](#) to acquire and lock on to target, at the same time radarscope scale changes to 5-mile range.

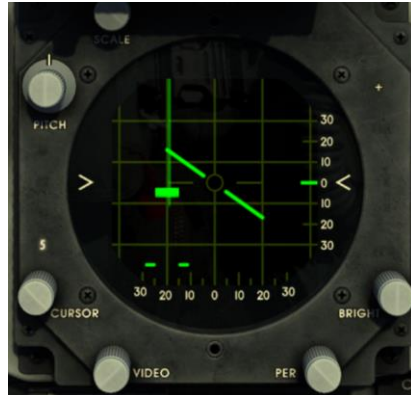

2. If target is between 500 and 5600 ft range, radar locks on to target automatically.

After the target is locked on:

- LK ON light comes on;
- Targeting information is shown on reticle.

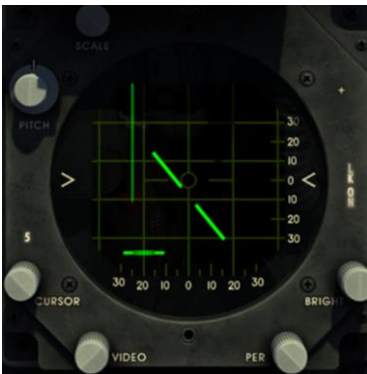

Target attack:

1. After visual contact with target, maneuver the aircraft to align reticle pipper with target. Keep sight reticle pipper over target by maneuvering the aircraft.



2. IN RANGE light comes on and in-range marker is displayed on optical sight when aircraft reaches launch range of 2700 ft. Trigger - Squeeze (Second Detent) |Space|.



In DM, DG and GUN modes, the radar stores target parameters for 1.75 s in after target lock-on is lost. The radar continues to track the target if it appears within 1.75 s. If the target does not appear, the radar initiates search phase. The radar needs to be locked on to the target once again.

If it is necessary to break the lock-on, momentarily press the DOGFIGHT/RESUME SEARCH switch to the forward position in DM mode |5| or to the aft position in DG mode |6| or momentarily press the ACQ button |Enter|.

Momentarily press the ACQ button in GUN mode |Enter|.

Range gate resumes slewing from rejected target to lock on to the first target that is at least 450 feet or further in range.

If the target is locked on in MSL and GUN modes, transition to DM and DG modes does not break target lock-on.

Press DOGFIGHT/RESUME SEARCH Switch on the aircraft control stick to reinitiate target search |R|.

Pressing and holding the ACQ switch causes the range gate to return and stow at minimum range.

OPTICAL SIGHT OPERATION DURING AIR-TO-AIR COMBAT

AIM-9P Missile Employment

Target search and acquisition:

1. Acquire target visually.
2. Select MSL mode on the sight control panel |0|.



3. Set GUNS/MISSILE and CAMERA switch to top position (1) |LCtrl + LShift + G|. Turn on position selector switches of wingtip launchers with AIM-9 missiles (2) on armament control panel (|LCtrl + LShift + 1| – left wingtip; |LCtrl + LShift + 7| – right wingtip).



Target lock-on and tracking:

1. Maneuver the aircraft to take attack position at target range of 5000 to 7000 ft and align reticle pipper with target.

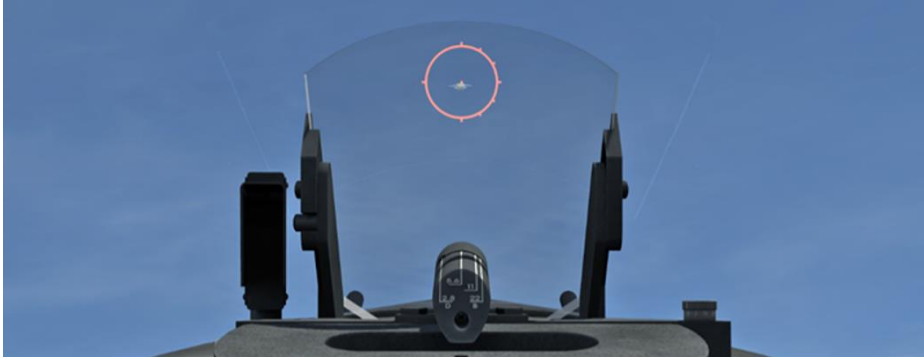

2. Keep reticle pipper positioned over target and continue target approach until seeker locks on to target. Press and hold MISSILE UNCAGE switch after seeker lock-on to facilitate maneuvering to advantageous attack position [**RShift + M**].

**Target attack:**

1. Push bomb-rocket button after attack position is achieved [[RAIt](#) + [Space](#)].
2. Launch range is to be determined by comparison of visible target size with reticle diameter
[Figure 7.12](#)

***SCOPE SIGHT OPERATION DURING AIR-TO-AIR COMBAT
WITH M-39A3 GUNS******A/A1GUNS Mode Employment***

Target search and acquisition:

1. Acquire target visually.
2. Set GUNS/MISSILE and CAMERA switch to top position [**LCtrl** + **LShift** + **G**].



3. Set sight mode selector to A/A1 position [**2**].



Target attack:

1. Maneuver the aircraft to attack position at 1500 ft target range, 90 kt approach speed.
2. The task is to project target and pipper motion to a point of intersection and to fire approximately one projectile time-of-flight before intersection would occur.



3. Fire at 1500 ft range [|Space|](#).
4. Firing range and distance to the target are determined by comparing visible target size with reticle diameter [Figure 7.12](#)



A/A2GUNS mode employment

Target search and acquisition:

1. Acquire target visually
2. Set GUNS/MISSILE and CAMERA switch to top position [|LCtrl + LShift + G|](#).



3. Set sight mode selector to A/A2 position [3].



Target attack:

1. Maneuver the aircraft to attack position at 1500 ft target range, 90 kt approach speed. Perform target approach and maneuver the aircraft to align reticle pipper with target, keep reticle pipper over target by equalizing angular velocities.



1. Fire at 1500 ft range |Space|. Firing range and distance to the target are determined by comparing visible target size with reticle diameter [Figure 7.12](#)



WARNING: When the trigger is fully squeezed to the second detent, firing is carried out in 0,25 s. Take this into account when firing.

10.2 Air-to-ground Combat Employment

MK-82, 83, 84 and M117 Bomb Dropping

1. Set sight mode selector to MAN position on AN/ASG-31 control panel (1) |4|.
2. Use RETICLE DEPRESSION knob (2) to select reticle depression required for bombs and based on employment conditions [Table 10.1](#).

|RCtrl +]| – increase angle of the reticle;
|RCtrl + [| – decrease angle of the reticle.



3. Set EXTERNAL STORES switch to BOMB position (1) (cyclical switching **|LCtrl + LShift +]|** or **|LCtrl + LShift + [|**).
4. Set Bombs Arm switch as required by fuze configuration in bomb (2) (**|LCtrl + LShift + E|** or **|LCtrl + LShift + F|**).
5. Select pylons with bombs on armament control panel (3).
|LCtrl + LShift + 2| – left outboard pylon;
|LCtrl + LShift + 3| – left inboard pylon;
|LCtrl + LShift + 6| – right outboard pylon;
|LCtrl + LShift + 5| – right inboard pylon.



6. Approach target at specified speed and altitude [Table 10.1](#). Maneuver so as to position target at specified line-of-sight angle. As soon as target is at specified line-of-sight angle, initiate diving.



7. Dive so as to locate sight pipper below target.



8. As the aircraft descends, move sight piper to the center of target upon approaching the altitude and speed specified for a given dive bombing condition. When specified altitude is reached, press BOMB-ROCKET button [RAlt + Space] and perform 4-G pullout which has to be done in 2 seconds.

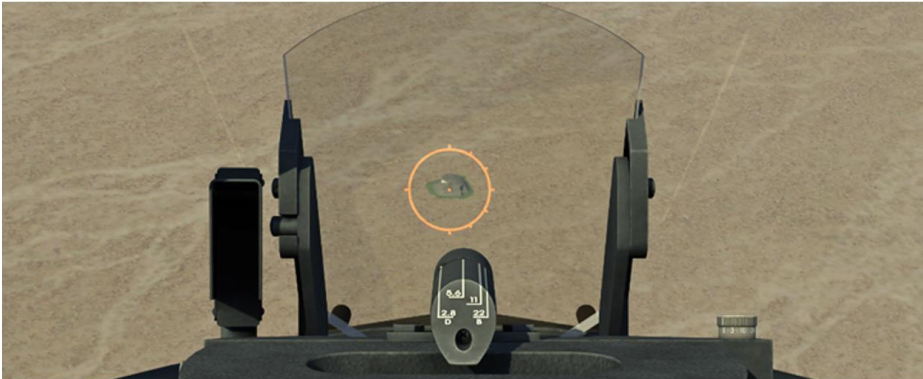

Table 10.1 Dive bombing

Parameter	Dive angles, degrees	
	20	30
Dive initiation altitude, feet	5000	6000
Dive initiation speed, knots	350	350
Release altitude, feet	1500	2000
Release speed, knots	380 to 400	440 to 450
Reticle depression, mils	80	79

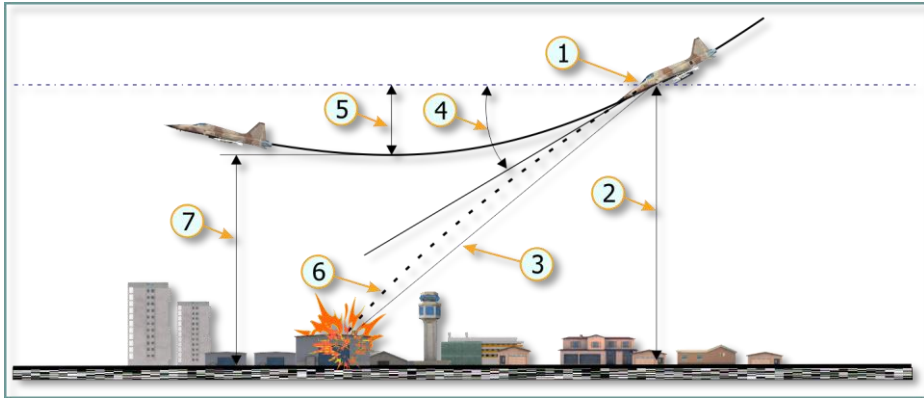

Figure 10.1 Dive bombing

- | | |
|----------------------------------|-------------------------|
| 1. BOMB RELEASE -START PULLOUT | 5. ALTITUDE LOST |
| 2. RELEASE ALTITUDE ABOVE TARGET | 6. BOMB TRAJECTORY |
| 3. SIGHT LINE | 7. MINIMUM ALTITUDE AGL |
| 4. DIVE ANGLE | |

NOTE: Bomb release interval can be adjusted. For this purpose, set the EXTERNAL STORES switch to RIPL position (1) (cyclical switching |LCtrl + LShift + J] и |LCtrl +LShift + [|). Set INTERVAL switch (2) to an appropriate position (cyclical switching up - |LCtrl + LShift + Q|; down - |LCtrl + LShift + A|).



Perform roll-in and aiming in a regular manner, when the specified release altitude is reached press the BOMB-ROCKET button |RAlt + Space| and hold it during the specified time interval at the same time keeping the specified dive angle.

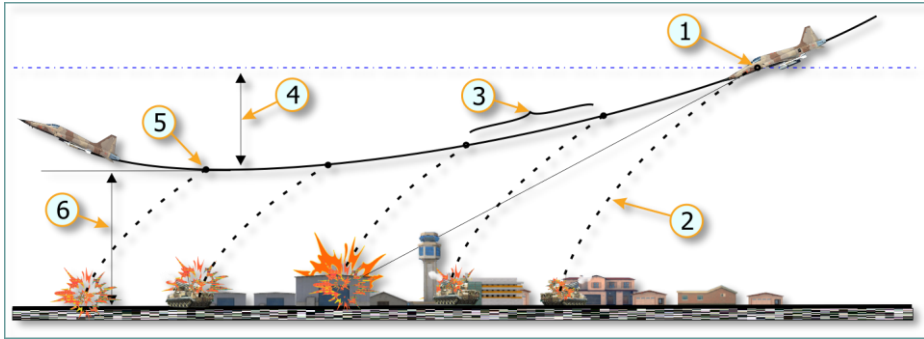

Figure 10.2 Ripple release bombing

- | | |
|--------------------------|-------------------------|
| 1. FIRST BOMB RELEASE | 4. ALTITUDE LOST |
| 2. BOMB TRAJECTORY | 5. LAST BOMB RELEASE |
| 3. BOMB RELEASE INTERVAL | 6. MINIMUM ALTITUDE AGL |

Rocket Attack

1. Set rocket firing mode, single or ripple, before flight ([Adjust controls – Category Ground Adjustment](#)). Selection for single or ripple must be made before starting engines.
2. Set sight mode selector to MAN position (1) on AN/ASG-31 control panel [|4|](#).
3. Use RETICLE DEPRESSION knob (2) to select reticle depression required for rockets based on employment conditions [Table 10.2](#)
 |RCtrl +]| – increase angle of the reticle;
 |RCtrl + [| – decrease angle of the reticle.



4. Set EXTERNAL STORES switch to RKT/DISP position (1).

5. Select pylons with LAU-68/A or LAU-60 on the armament control panel (2).



6. Approach target at specified speed and altitude [Table 10.2](#). Maneuver so as to position target at specified line-of-sight angle. As soon as target is at specified line-of-sight angle, initiate diving.



7. Start diving so as to locate sight pipper below target.

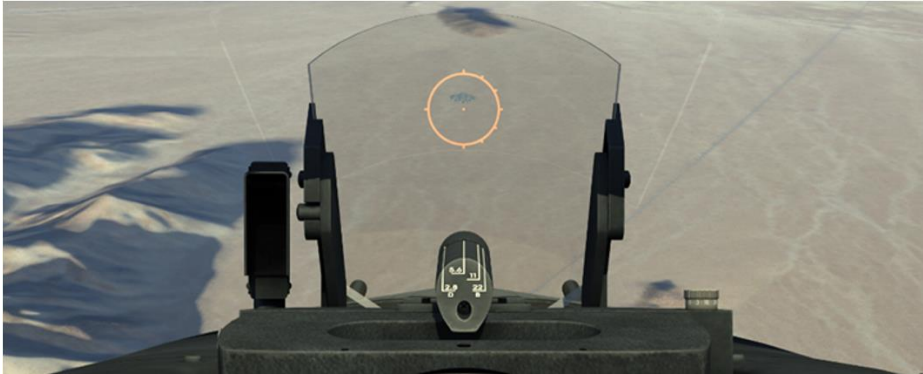

- Align sight piper with target and keep it over target. When specified altitude is reached, press BOMB-ROCKET button [**RAlt** + **Space**] and perform 4-G pullout which has to be done in 2 seconds.

Table 10.2 Air-to-Ground Rocket Attack HYDRA/FFAR

Parameter	Dive angles, degrees	
	20	30
Dive initiation altitude, feet	5000	6000
Dive initiation speed, knots	350 to 370	350
Rocket firing altitude, feet	1500	2000
Rocket firing speed, knots	400	400
Reticle depression, mils	14/34	10/30

Gun Attack

- Set sight mode selector to MAN position (1) on AN/ASG-31 control panel [4](#).
- Use RETICLE DEPRESSION knob (2) to select reticle depression as required by gun employment conditions ([Table 10.3](#))
 [**R**Ctrl + **]** – increase angle of the reticle;
 [**R**Ctrl + **[** – decrease angle of the reticle.



3. Set GUNS/MISSILE and CAMERA switch to top position [**L**Ctrl + **L**Shift + **G**].



4. Approach target at specified speed and altitude ([Table 10.3](#)). Maneuver so as to position target at specified line-of-sight angle. As soon as target is at specified line-of-sight angle, initiate diving.



5. Start diving so as to locate sight pipper below target.
6. Align sight pipper with target and keep it over target.
7. When specified altitude is reached, squeeze TRIGGER [Space] and perform 4-G pullout which has to be done in 2 seconds.



Table 10.3 Air-to-Ground Gun Attack

Parameter	Dive angles, degrees	
	20	30
Dive initiation altitude, feet	5000	6000
Dive initiation speed, knots	350 to 370	350 to 370
Firing altitude, feet	2000	3000
Speed at the moment of firing, knots	400	400
Reticle depression, mil	12	8

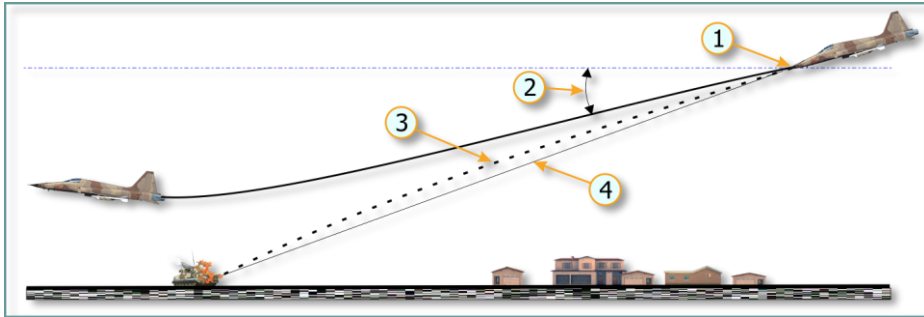

Figure 10.3 Air-to-ground gun attack

- | | |
|---------------|----------------------|
| 1. OPEN FIRE | 3. BULLET TRAJECTORY |
| 2. DIVE ANGLE | 4. SIGHT LINE |

Flare Drop

1. Set sight mode selector to MAN position [|4|](#) on AN/ASG-31 control panel.
2. Set EXTERNAL STORES switch to RKT/DISP position (cyclical switching clockwise [|LCtrl + LShift + J|](#), cyclical switching counterclockwise [|LCtrl + LShift + I|](#)).
3. Select pylons with SUU-25 dispensers on armament control panel
[|LCtrl + LShift + 2|](#) – left outboard pylon;
[|LCtrl + LShift + 6|](#) – right outboard pylon.
4. Perform horizontal target approach at speed of 300–400 knots and at altitude not less than 1000 ft.
5. Push BOMB-ROCKET button [|RAIt + Space|](#). Two flares are released every time the button is pressed.

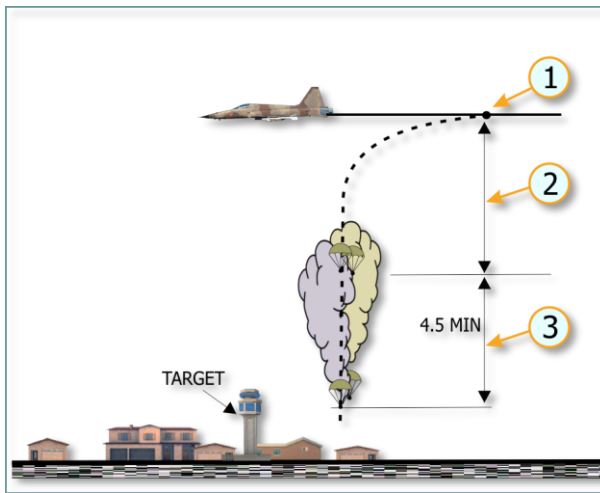

Figure 10.4 Flare drop profile

1. RELEASE
2. FREE FALL (DELAY TIME)
3. CHUTE OPEN & IGNITION.

Laser-guided bomb delivery using a JTAC

Laser designation is performed by a JTAC (Joint Terminal Attack Controller) on a Stryker ICV (Infantry Carrier Vehicle). Target is marked with the white smoke.

1. After takeoff set the proper frequency on the AN/ARC-164 radio control panel frequency to contact the JTAC.



2. Reach engagement area at an altitude of 3000 feet and speed of 450 knots.
3. Switch microphone to the transmitting mode [[RAlt](#) + [\](#)]. In the pop up menu, by pressing the F4 button, select JTAC submenu.

[UHF Radio AN/ARC - 164](#)

[Main](#)

[F1. Flight...](#)

[F2. Wingman 2...](#)

[F3. Wingman 3...](#)

- F4. JTAC – Axeman 11...
 - F5. ATC...
 - F8. Ground Crew...
 - F12. Exit
4. Select the check-in time in the JTAC submenu.
 - UHF Radio AN/ARC – 164
 - 2. Main. JTAC – Axeman 11
 - F1. Check – in 15 min
 - F2. Check – in 30 min
 - F3. Check – in 45 min
 - F4. Check – in 60 min
 - F11. Previous Menu
 - F12. Exit
 5. After selecting “Check-in time” you will inform the JTAC of your current position, weapon, and play time.
 - PLAYER: Axeman 1–1, this is Enfield 1–1, 1 x F-5E-3
 - GG1610 at 450
 - I have: GBU-12, 300 x ВПУ
 - Play time is 0 + 30
 - Available for tasking. What do you have for us?
 6. Wait for a response from the JTAC and confirm that you are ready to receive target information (9- line).
 7. JTAC (Axeman 11): Enfield 1–1, this is Axeman 1–1. type 2 in effect. Advise when ready for 9 – line.
 8. By pressing the **|F1|** button, confirm that you are ready to receive target information (9- line).
 - Axeman 11. JTAC. Ready for 9 – line.
 - F1. Ready to copy
 - F2. Check out
 - F11. Parent Menu
 - F12. Exit
 9. Receive information about target (9-line).
 - JTAC (Axeman 11): line is as follows
 - 1,2,3 N/A
 - [4. Elevation:] 3000 feet MSL
 - [5. Target:] Tank
 - [6. Coordinates:] GG 323360

Note: Coordinates are given in the UTM (Universal Transverse Mercator) system. The first three digits and the sixth correspond to the grid (GG33). The fourth and fifth digits is the horizontal distance from the left lower corner. The fifth and sixth digit define the vertical location. In this case, the target is located in the middle of intersecting runways.

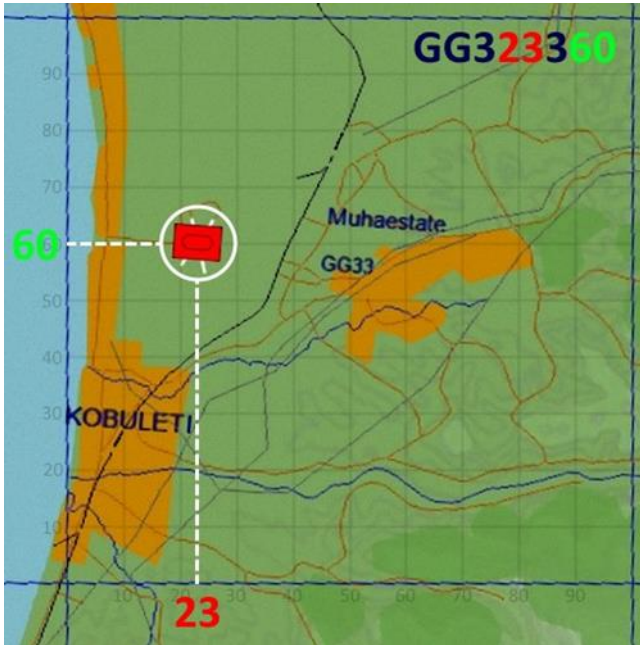

[7.] Marked by WP + Lazer, 1688

[8. Friendlies:] west 1000 meters, troops in contact

[9.] Egress east

NOTE: 9-LINE (nine-line briefing) is information about ground target.

9-LINE contains the following information:

- Initial Point (IP) coordinates. (not used in game);
- Heading (IP to Target). (not used in game);
- Distance (IP to Target). ((not used in game);
- Target Elevation (Feet Above Mean Sea Level);
- Target Description;
- Target location (UTM);
- Type Of Mark;
- Location Of Friendlies;
- Egress.

10. Once the target information (9-line) has been transferred, the JTAC will ask you if you are ready for remarks and further talk-on details.

JTAC (Axeman 11): *advise when ready for remarks and further talk-on*

- Use the |RAlt+ \| to bring up the radio menu.
- Press |F1| to confirm that you are ready.

NOTE: Remarks contain information about weapon to be used and wind direction.

UHF Radio AN/ARC – 164

Axeman 11. JTAC. Ready for remarks

F1. Ready to copy remarks

F2. Unable to comply

F3. Check out

F11. Parent Menu

F12. Exit

11. JTAC transfers information about weapon to be used.

JTAC (Axeman 11): *request GBU-12*

12. Once remarks has been received, pilot must perform 9-line readback.

- Use the |RAlt+ \| to bring up the radio menu.
- Press |F1| to send the 9-line readback.

UHF Radio AN/ARC – 164

Axeman 11. JTAC. 9-line readback

F1. 9-line readback

F2. Unable to comply

F3. Check out

F11. Parent Menu

F12. Exit

13. After readback, the JTAC will confirm that information is correct.

JTAC (Axeman 11): *readback correct*

14. After 9-line readback, the JTAC will confirm that information is correct and ask you to report when you reach the ingress Point (IP). Ingress point is a point from which airplane flies to the target with a course given by a JTAC.

JTAC (Axeman 11): *report IP INBOUND*

15. Before reaching ingress point prepare equipment to bomb delivery.

- set the EXTERNAL STORES switch to the BOMB position;
- by the Bombs Arm switch set the GBU-12 bomb detonators to a required position;
- on the weapon panel, select one or two GBU-12s, on the inner pylons, by setting the corresponding pylon selection switches to the up position.

16. After passing the IP, report to the JTAC.

- Use the |RAlt+ \| to bring up the radio menu.
- Press |F1| to report "IP INBOUND".

UHF Radio AN/ARC – 164

Axeman 11. JTAC. Ready for action

F1. IP INBOUND

F2. Report brief

F3. What is my target?

F4. Contact

F6. Unable to comply

F7. Check out

F11. Parent Menu

- F12. Exit
17. Receive confirmation from the JTAC.
JTAC (Axeman 11): Enfield 1–1 Continue
 18. While flying towards your target, the JTAC will mark the target with a smoke marker and ask that you to confirm that you see the smoke.
JTAC (Axeman 11): mark is on deck?
 19. Look at the area, where the target should be; observe the smoke and confirm it.
 - Use the |RAIt+ \| to bring up the radio menu.
 - Press |F1| to report "Contact the mark".
UHF Radio AN/ARC – 164
Axeman 11. JTAC. Wait for smoke spot
F1. Contact the mark
F2. Report brief
F3. What is my target?
F4. Contact
F6. Unable to comply
F7. Check out
F11. Parent Menu
F12. Exit
 20. The JTAC will point where the target is located relative to the smoke.
JTAC (Axeman 11): from the mark south 18 meters
 21. Detect the target visually and give the command to the JTAC to enable laser.
 - Use the |RAIt+ \| to bring up the radio menu.
 - Press |F1| to command "LAZER ON".
UHF Radio AN/ARC – 164
Axeman 11. JTAC. Wait for lazer
F1. LAZER ON
F2. Report brief
F3. What is my target?
F4. Contact
F6. Unable to comply
F7. Check out
F11. Parent Menu
F12. Exit
 22. Receive confirmation from the JTAC that LAZER is ON.
JTAC (Axeman 11): LAZER ON RESPOND
JTAC (Axeman 11): LASING
 23. Report that you are IP inbound.
 - Use the |RAIt+ \| to bring up the radio menu.
 - Press |F1| to report "IP INBOUND".
UHF Radio AN/ARC – 164
Axeman 11. IP INBOUND
F1. IN
F2. Unable to comply
F3. What is my target?
F4. Contact
F6. Unable to comply
F7. Check out
F11. Parent Menu
F12. Exit

24. Receive permission to attack the target.

JTAC (Axeman 11): Enfield 1-1 CLEARED HOT!

Once you receive permission to attack the target, continue closing the distance to the target at 3,000 feet ASL and a speed of 450 knots.

Maneuver the aircraft such that the target is moving between lower part of the gun camera and the barrel of one of the cannons.

As soon as target reaches the nose of the aircraft, press the release button and make a turn away from the target based on the directed egress. Report to the JTAC that you are finished.

If the target was not destroyed, JTAC will report you about it.

JTAC (Axeman 11): Enfield 1-1, target not destroyed. Cleared to re – attack.

Fly to the ingress point (IP) and inform JTAC before re-attacking the target. After that, follow the radio communication procedures as described above.



Figure 10.5 Position of the target at the moment when the bombs must be released.

Table 10.4 Deployments parameters for GBU-12

Altitude above target, feet	≈Dmin nm/km	≈Dmax nm/km	IAS
3000	2,8/4.5	2,8/4.5	450
5000	3/5.5	3/5.5	400
10000	3,3/6	5/9	300
20000	4/7	6,5/12	300
30000	5/9	8/15	300

The GBU-12 laser-guided bombs can be deployed at various altitudes and speeds. Bombing can be performed in level flight, in a shallow (or steep) dive, or loft.

Loft bombing is used against targets protected by air defenses.

Arrive at the target area at an altitude of 500 feet and a speed of 400 knots. To increase precision, use the TACAN system. Target radial and distance must be defined in advance.

At distance of 4 miles to the target, begin climbing with a pitch of 30° and G-load of 4 units while in afterburner mode. At an altitude of 2,500 feet, release the bombs, turn away from the target, and return to very low altitudes for egress.

If you do not plan to use the TACAN system for navigation, use reference points for navigation and finding the ingress point. When ingressing, select a reference point at a distance of 4-5 miles to the target. When this specific reference point is reached, perform a climbing maneuver, followed by bomb release.

INSTRUMENT MARKINGS (TYPICAL)



EHU-31/A EHU-31A/A
EXHAUST GAS TEMPERATURE



OIL PRESSURE



ENGINE TACHOMETER

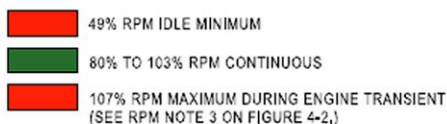

Note
EGT MARKINGS BASED ON ANY AUTHORIZED FUEL (SEE SERVICING DIAGRAM).



HYDRAULIC PRESSURE



ACCELEROMETER

E / F / N

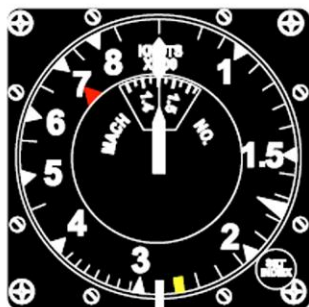



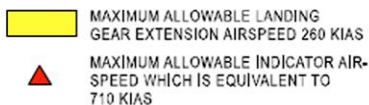

AIRSPEED-MACH INDICATOR



11 FLIGHT AND OPERATIONAL LIMITATIONS

11 FLIGHT AND OPERATIONAL LIMITATIONS

Engine performance indicators and limitations

<p>Engine RPM</p>		<p>IDLE: 49 to 52 %; Continuous mode: 80-103 %; Maximum allowable exceeding of engine RPM: 107 %; MIL (military) 90-103 %; MAX (afterburner) 90-103 %; RPM fluctuations ± 1 % at all modes.</p>
<p>Exhaust gas temperature</p>		<p>Minimum: 140°C; Stable continuous operation: 325 -650°C; Maximum: 685°C; Maximum allowable exceeding of temperature during start up and acceleration: 925°C; Allowable temperature range at afterburner operation: 675 - 685°C; Normal temperature fluctuation: $\pm 7,5$°C</p>
<p>Engine oil pressure</p>		<p>Minimum: 5 psi; Normal operating range at all power modes: 20 - 55 psi; Allowable excessive pressure at MIL and MAX modes: 55 to 100 psi; Normal fluctuations: ± 2 psi; Allowable oil pressure drop to 0 psi while engine is operating: 60 s maximum.</p>
<p>Engine nozzle position</p>		<p>IDLE: 70 - 80 %; MIL: 0-16 %; MAX: 50-80 %; Normal fluctuations: ± 3 %</p>

Overspeed or Overtemperature

If engine RPM exceeds 103 % or EGT exceeds 675 °C during steady engine operation, retard the throttle until the gauges readings are within, mentioned above, limits.

Fuel system limitations

1.	Less than 650 pounds of fuel in either system	Avoid steep descending at high engine RPM At high fuel flow rates (more than 6000 pph) CROSSFEEDING should be off	Can result in engine flameout due to low remaining fuel level
2.	Boost pumps are off (inoperative)	Avoid fuel flow rates above 9800 pph at altitudes above 25,000 feet	Can result in engine flameout
3.	Sustained 0-G flight	Avoid such flight conditions at high engine RPM	Can result in engine flameout
4.	Negative-G	<p>A. Allowable time in negative G, sec B. Indicated fuel flow, per engine 1000 lb/hr C. Engine oil system limit, sec D. Engine flameout area</p>	Exceeding the operation time limitations can result in engine flameout

Flight Limitations

1.	Maximum taxiing speed with open canopy	50 KIAS	Strength of the canopy hinges in open position
2.	Maximum Drag chute deployment speed	180 KIAS	Strength of Drag Chute release mechanism. Drag Chute is deployed after nosewheel lowering.
3.	Maximum landing gear extension speed	260 KIAS	Strength of landing gear door hinges.
4.	Maximum landing light retraction speed	300 KIAS	Retraction force of the light retraction mechanism
5.	Maximum nosewheel steering engagement speed	65 KIAS	Taxiing safety (possibility of flipping over the airplane)
6.	Maximum crosswind component during landing	20 KNOTS (10 m/s) with drag chute; 35 KNOTS (18 m/s) without drag chute.	Yaw stability during roll. Possibility of veering off the runway.
7.	Recommended descent rates on the glide path before landing	Airplane has less than 3700 pounds of fuel– 600 feet per minute (400 feet per minute at crosswind); Airplane has more than 3700 pounds of fuel– 360 feet per minute (300 feet per minute at crosswind)	Main landing gear strength. Decrease in descent rate due to increased weight is conditioned by increased translational speed, required for maintaining specified angle of attack during landing approach.
8.	Maximum takeoff run groundspeed	230 KIAS	Wheel tires strength.
9.	Maximum airspeed without pylons (with missiles on wingtip launchers)	710 KIAS or 2.0 M	2.0 M can be achieved during descending
10.	Maximum G without pylons (with missiles on wingtip launchers)	+ 7,3 - 3	
11.	Maximum speed with one centerline external tank	650 KIAS or 1.4 M	
12.	Maximum speed with load on inboard (or outboard) pylons and centerline external tank	600 KIAS or 1.2 M	
13.	Maximum speed with three external tanks (150-gallon tanks on wing pylons)	560 KIAS or 1.2 M	

14.	Maximum speed with wing weapon stores and centerline external tank	520 KIAS or 0.85 M	
15.	Maximum G with stores	+6.5 -2.0	
16.	Maximum speed with armament on outboard pylons and external tanks (275 gallons) on inboard pylons. Note: If external tanks are empty, the same limitations are applicable, as those that apply to weapon stores.	450 KIAS or 0.8 M	
17.	Maximum G with loaded external weapon stores and inboard external tanks (275 gallons).	+4 -1,5	

Prohibited maneuvers

- Inverted spins.
- Exceeding 28 units AOA, read on corresponding gauge, during maneuvering.
- Exceeding 20 units AOA with centerline store installed or with asymmetrically installed stores (regardless of flap position)
- Multiple barrel rolls
- Exceeding negative 2 G with speed brake extended.
- 360-degree full deflection aileron rolls at load factors greater than 5 g without pylon stores or 1 g with pylon stores.
- Abrupt full deflection of rudder with empty 275-gallon centerline external tank
- Abrupt full deflection of rudder with empty 150-gallon centerline external tank at airspeeds above 400 KIAS
- Sharp full deflection of rudder or full roll stick input with outboard external load

EJECTION SEQUENCE

STANDARD SEAT

Note

- TIME FROM TRIGGER SQUEEZE TO FULL PARACHUTE DEPLOYMENT FOR PARACHUTES WITH 0.25-SECOND DELAY OR ZERO DELAY (LANYARD ATTACHED) IS 3.6 - 4.8 SECONDS, OR 4.6 - 5.8 SECONDS FOR 1-SECOND DELAY (ZERO-DELAY LANYARD STOWED), AT AN EJECTION AIRSPEED OF 150 KIAS.
- VARIABLES SUCH AS LOWER AIRSPEEDS AND THE ATTITUDE OF THE CREWMEMBER AT TIME OF PACK OPENING CAN INCREASE PARACHUTE DEPLOYMENT TIME.

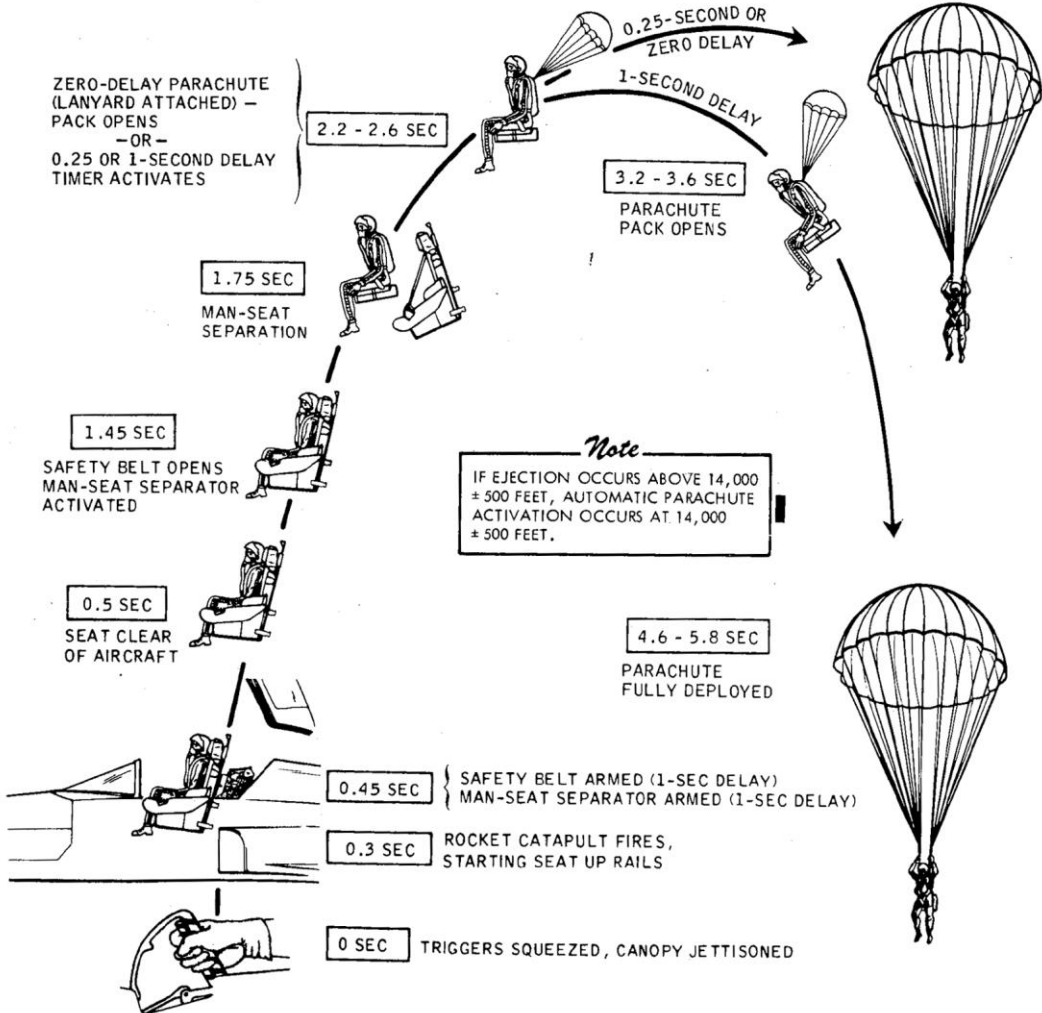

12 EMERGENCY PROCEDURES

CADC / Pitot-Static System Malfunction

Illumination of the **AIR DATA COMPUTER** caution light indicates a failure of the CADC due to its malfunction or as a result of erroneous data inputs from the faulty pitot-static system.

Required actions:

- Check that pitot heating is ON (switch it on, if it was switched off);
- Pitch damper switch - OFF (pitch may become excessively sensitive at high airspeed with pitch damper on);
- AAU-34 Altimeter – in **PNEU** mode;
- Flap Lever - FULL (for approach and landing);

CAUTION. Use of auto or fixed flap setting with unreliable CADC output may result in unexpected changes in flap position and possible flap overspeed.

- Engine Aux Door Circuit Breakers - Pull (if desired). Pull left and right ac engine aux door circuit breakers to preclude the possibility of door cycling and unexpected loss of thrust.

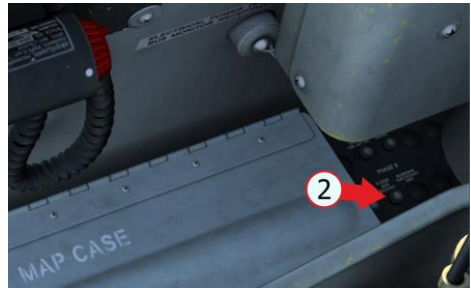

Incorrect readings of angle-of-attack and air speed are possible while landing (in the case of pitot-static system failure).

In case of pitot-static system malfunction the following gauges and systems are inoperative:

- Altimeter;
- Airspeed indicator;

Optical Sight System;
Stability Augmenter System;
Flaps Audible Warning;
Landing Gear Warning

Flaps AUTO mode failure

Illumination of the **AOA/FLAPS** annunciator indicates the failure in the AOA electronic unit. In this case, flaps remain in the position, they were at the time of failure (if AUTO mode was enabled).

Required actions:

- Use manual control of Flaps;
- Flap lever should be in the UP position during flight and in the FULL position for landing

Inoperative:

Automatic flaps operation (AUTO)

Engine fire

Illumination of the left or right engine FIRE warning light indicates fire in the corresponding engine compartment.

Required actions:

- Engine throttle, corresponding to affected engine– OFF;
- Cut off fuel supply by closing the fuel shutoff valve left engine (1) or right engine (2);

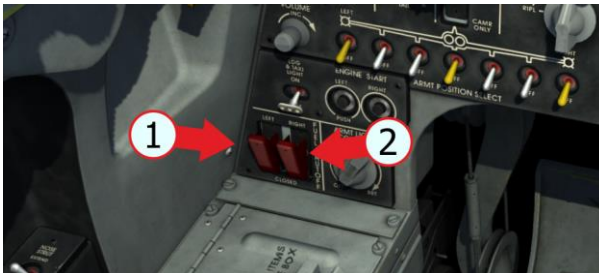

- Flight and landing are performed with one working engine.
- If fire is confirmed — EJECT

Single-Engine Takeoff

In case of single-engine takeoff:

- Use afterburner during takeoff;
- Jettison stores;
- Use pedals to maintain direction;
- To lift up the nose gear, aft the control stick at approximately 5 KIAS before single-engine takeoff speed [Table 8.2](#), if runway permits, lift-off can be made at 210 KIAS (not more, due to landing gear tires limitations);
- Single operating engine ensures minimum climb rate of 300 ft/min with extended flaps and landing gear (at full afterburner; with full fuel tanks, without stores).

Table 12.1 Recommended Single-Engine Climb Rate

Gear	Flaps	Climb Rate, KIAS
Down	AUTO	210
Up	AUTO	230
Up	Retracted	290

In-Flight Engine Failure

Perform the following actions in case of in-flight engine flameout and if the airstart is not possible:

- Increase RPM of operating engine to maintain safe airspeed;
- Jettison stores, if necessary;
- Retract landing gear (if extended);
- Retract speed brake (if extended);
- Failed engine throttle – OFF;
- Use fuel autobalancing (to use fuel from the failed engine fuel system and to maintain airplane balance within the acceptable limits).

The following equipment is inoperative in case of left engine failure:

- Airbrakes;
- Normal landing gear extension;
- Nosewheel steering;
- Pitch and yaw damper;

Gun gas deflector and gun bay purge doors;
Normal braking.

Single-Engine flight

In case of single-engine flight, directional control is maintained at all speeds by small rudder pedal deflection. The aircraft may not maintain specified altitude with single engine operating, when landing gear and flaps are extended and fuel tanks are full. In this case, descending is required to maintain airspeed.

The minimum safe single-engine flight speed with gear and flaps retracted and external stores jettisoned is 190 KIAS (add 1 KIAS for each 1 °C above the standard ambient temperature conditions).

Minimum single-engine climb rate (gear and flaps retracted, no external stores) is 300 ft/min.

Airstart

Airstart can be performed at altitudes below 25,000 feet and at airspeeds, providing optimal engine windmill speed. Airstart at airspeeds below ones, required for windmill, may lead to engine overheat and hung up due to insufficient air supply to the combustor. Airstart at speeds higher than required windmill speeds may result in excessive air supply into the combustor, as a result EGT does not increase and stable combustion can not be achieved.

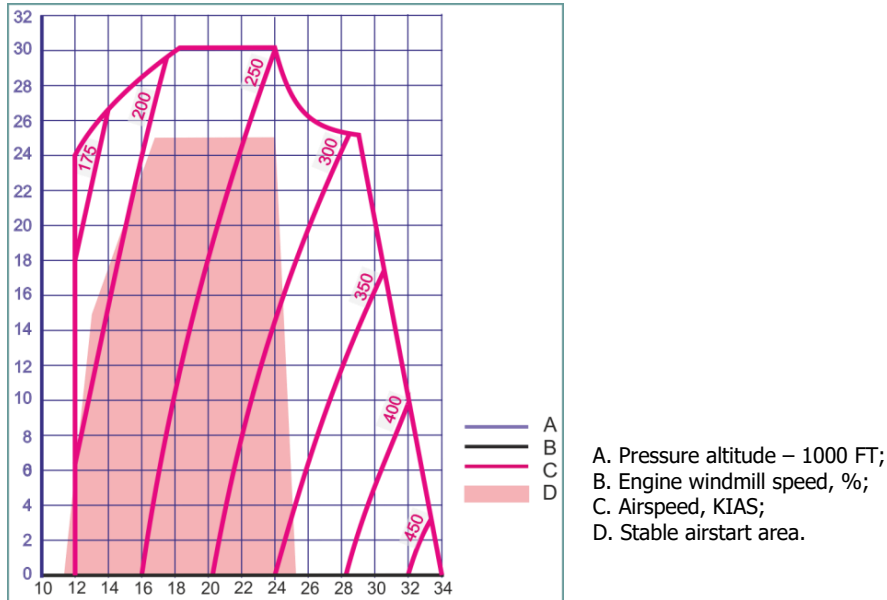

Figure 12.1 Airstart Envelope

Note: Airspeeds necessary to achieve engine windmill speed, required for successful airstart, are indicated on the diagram.

Engine airstart is performed automatically, when START button is pressed and the engine throttle is advanced from the OFF position to the IDLE position. If the engine throttle is set to a position between IDLE and MIL, the airstart can be performed by setting the engine throttle in the AB (afterburner) mode.

The ignition system operating time is 40 s. If the engine has not reached the idle RPM within 40 s, press START button once again and move the throttle to a position between IDLE and MIL to the AB (afterburner) mode.

Required actions in case of airstart:

- Set the failed engine throttle to OFF;
- Descend below 25,000 ft;
- Set speed from 240 to 250 KIAS;
- Press the engine START button;
- Set corresponding engine throttle to the IDLE;

- Observe engine parameters during airstart:
 - temperatures below 200 °C are not indicated;
 - approximately 25 seconds is required to reach the flight idle speed at a given altitude.
- Alternate airstart procedure:
- Set the throttle below MIL;
- Descend below 25,000 ft;
- Advance the throttle to MAX (afterburner);
- Observe engine parameters during airstart:
 - temperatures below 200°C are not indicated;
 - approximately 10 s is required to reach 100 % RPM and to switch on afterburner.

If both engines flamed out, always try to start the left engine first (utility hydraulic system is powered by the left engine hydraulic pump).

The glide distance with both engines inoperative at 240 KIAS with flight weight of 13,300 lb and flaps retracted is shown on the scheme below:

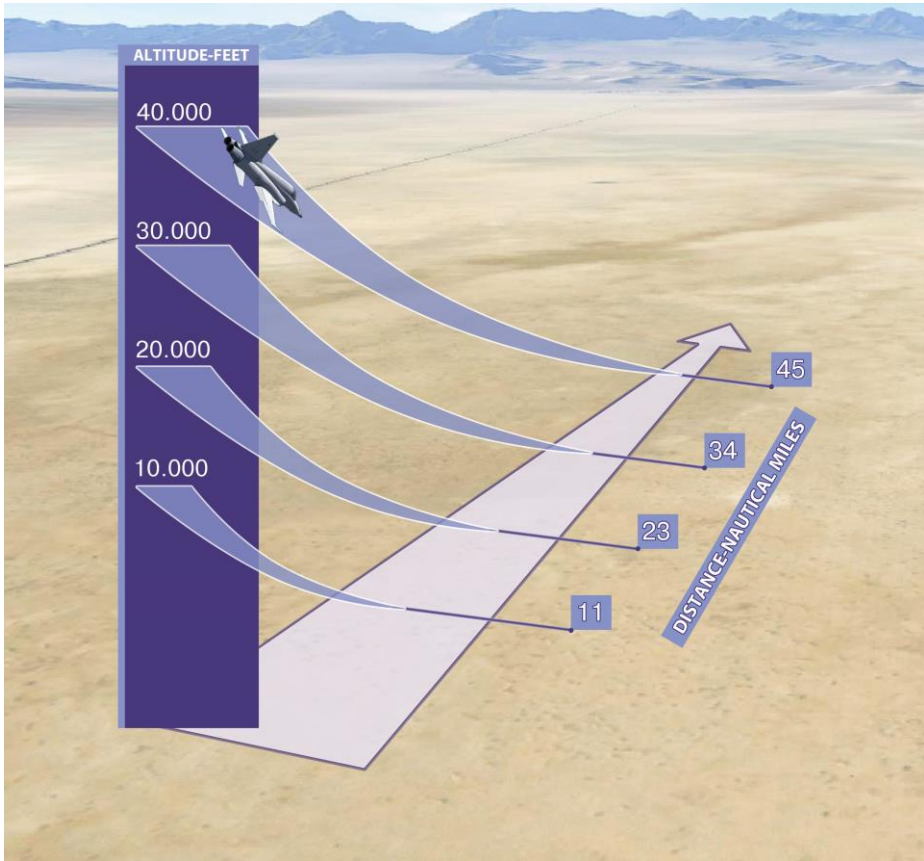

Figure 12.2 Glide Distance at 240 KIAS with Both Engines Inoperative

Single-Engine Approach and Landing

- Jettison stores and use afterburner if necessary, to maintain required landing speed;
- Extend gear and flaps on final approach;
- Approach, descend and land at speeds of about 10 KIAS above normal speeds, required for a given landing weight;
- Maintain angle-of-attack of 14 units on final approach;
- Use Drag chute during landing roll, if necessary.

No-Flap Approach and Landing

- Approach, descend and land at speeds of 10 KIAS above the normal speeds required for a given landing weight;
- Maintain angle-of-attack of 16.4 units on final approach.

Landing Gear Retraction Failure after Takeoff/Missed approach

The red warning light on the landing gear lever remains on after the lever has been moved to LG UP position. First, make sure that both engines RPM are above 96 %, when flying below 9,500 feet and at less than 220 KIAS.

- Maintain airspeed below 260 KIAS (yellow mark on the speed indicator);
- Set nose strut switch to RETRACT (dehike);
- Set landing gear lever to LG UP then LG DOWN;
- Set throttle to MIL;
- If the warning light on the landing gear lever remains on – set the landing gear lever to LG DOWN and prepare for landing;
- If the warning light is off – continue mission.

Landing Gear Alternate Extension

If the landing gear fails to extend normally:

- Set airspeed below 260 KIAS;
- Set the landing gear lever to LG DOWN (extended position);
- Pull the gear alternate release handle out (клавиша..) (unlocks landing gear locks and door locks);
- Stow alternate release handle back to fully in position (клавиша..);
- Check gear indicators, all three green lights should be on.

Landing gear extension time is approximately 35 s. If possible, create a positive-G and rock the wings to ensure reliable locking of landing gear locks in the extended position.

Note. It is still possible to land if the nose gear fails to extend. During landing run, smoothly lower the aircraft nose on the runway and release drag chute.

Engine stall

In case of engine stall (hang-up, EGT increase), proceed as follows:

- Decrease engine RPM until engine recovers from stall;
- Advance throttle slowly and increase airspeed;
- If engine does not recover, shut down the engine;
- Perform airstart.

Cockpit smoke

If there is smoke in the cockpit (as a result of combat damage, fire), it is necessary to:

- Switch on the oxygen - 100 % (1);
- Descend below 25,000 feet;
- Switch on the emergency oxygen supply – EMERGENCY (2);
- Cockpit Pressurization Switch — RAM DUMP (3);
- After smoke clears Cockpit Pressurization Switch — DEFOG ONLY (4);
- At speeds of less than 300 KIAS – jettison the canopy (if smoke is still present) (5)

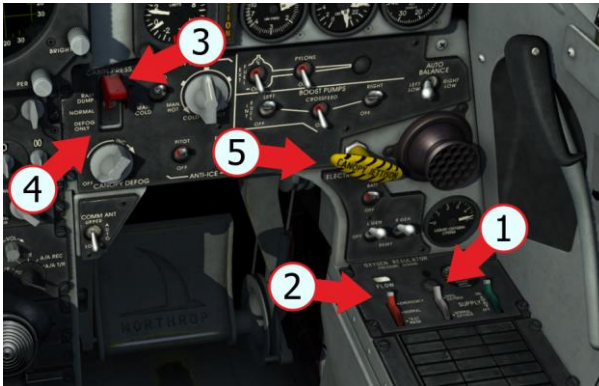

Nozzle Failure

The nozzle position indicator arrow does not response to changes in RPM.

If a failure occurs in closed range – don't allow EGT increase above the temperature marked with the red sector on the indicator (possible engine overheating and turbine destruction, resulting in a fire).

If a failure occurs in opened range, it's possible for engine to run between IDLE and MIL. Engine thrust will be decreased significantly. See single-engine flight instructions.

Loss of canopy

Don't exceed the speed of 300 KIAS, when canopy hinged portion is jettisoned or destroyed.

When the flight speed limit is exceeded, the air flow can switch off the circuit breakers on the back panels, leading to a loss of associated electrical equipment operation. (It is impossible to switch on the circuit breakers on the back panels during the flight).

Electrical system failure

In order to save the electrical battery charge, use only the equipment, which is necessary to perform the flight and landing.

- Lower the flight altitude to less than 25,000 ft;
- Check that the electrical battery is on – BATT;
- Reboot the generator (L GEN/R GEN) – RESET;
- Set the generator switch to the upper position (L GEN/R GEN);
- Land at the nearest airfield, if possible.

Note: Descending below 25,000 feet ensures that fuel system is functioning in case of boost pump failure due to voltage drop in the electrical system.

Inoperative equipment with electrical system failure:

- Flight instruments. Except for airspeed indicator (always on) and altimeter (is operating in STBY mode during 9 minutes after electrical system failure);
- Engine instruments;
- Airbrake;
- Flaps;
- Landing gear lever warning light;
- Nosewheel steering;
- Fuel system boost pump;
- Ignition system;
- Jettison system;

- Anti-icing system;
- External fuel system;
- Stability augments system;
- Roll and pitch trim;
- Arresting hook;
- Seat height adjustment.

Hydraulic Systems Failure

The following three hydraulic systems malfunctions may be encountered: pressure drop to less than 1500 psi; pressure increase to more than 3200 psi and hydraulic fluid overtemperature. Respective caution light comes on in case of pressure drop or overheat. Overheat is determined when the caution light is on and hydraulic pressure indicator shows normal pressure.

When both hydraulic systems fail, flight control becomes impossible. Eject from the aircraft.

If flight control hydraulic system fails, the control is still possible, because both utility and flight control hydraulic systems provide hydraulic power to the control surfaces.

Inoperative equipment with hydraulic systems failure:

- Normal landing gear extension;
- Nosewheel steering;
- Main wheel brake (smoothness, due to pressure increase in brakes);
- Airbrakes;
- Roll and pitch dampers.

If the pressure is high (determined only by the instrument) and the temperature is high, retard the throttle until the pressure is back to normal (less than 3200 psi) or until caution light goes off (if the pressure is normal, the temperature is normal too). Failure to retard the throttle of the affected engine may result in destruction of hydraulic line and failure of hydraulic system.

Airframe Gearbox Failure

A gearbox failure is indicated by simultaneous illumination of the generator and hydraulic caution lights for the same engine.

If Gearbox Fails:

- Throttle (affected engine) — OFF (if vibration exists).

Gearbox failure to shift is indicated when either generator caution light comes on when accelerating thru the 68 % to 72 % shift range.

If Gearbox Fails to Shift:

- Throttle — Reduce RPM (to range that sustains generator operation).
- Generator Switch — RESET, Then L GEN/R GEN, if necessary.
- Throttle — Maintain RPM (in range sustaining generator operation until starting final approach, then use as necessary to effect a safe landing).



13 SUPPLEMENTS

13 SUPPLEMENTS

Engine Fuel Control System

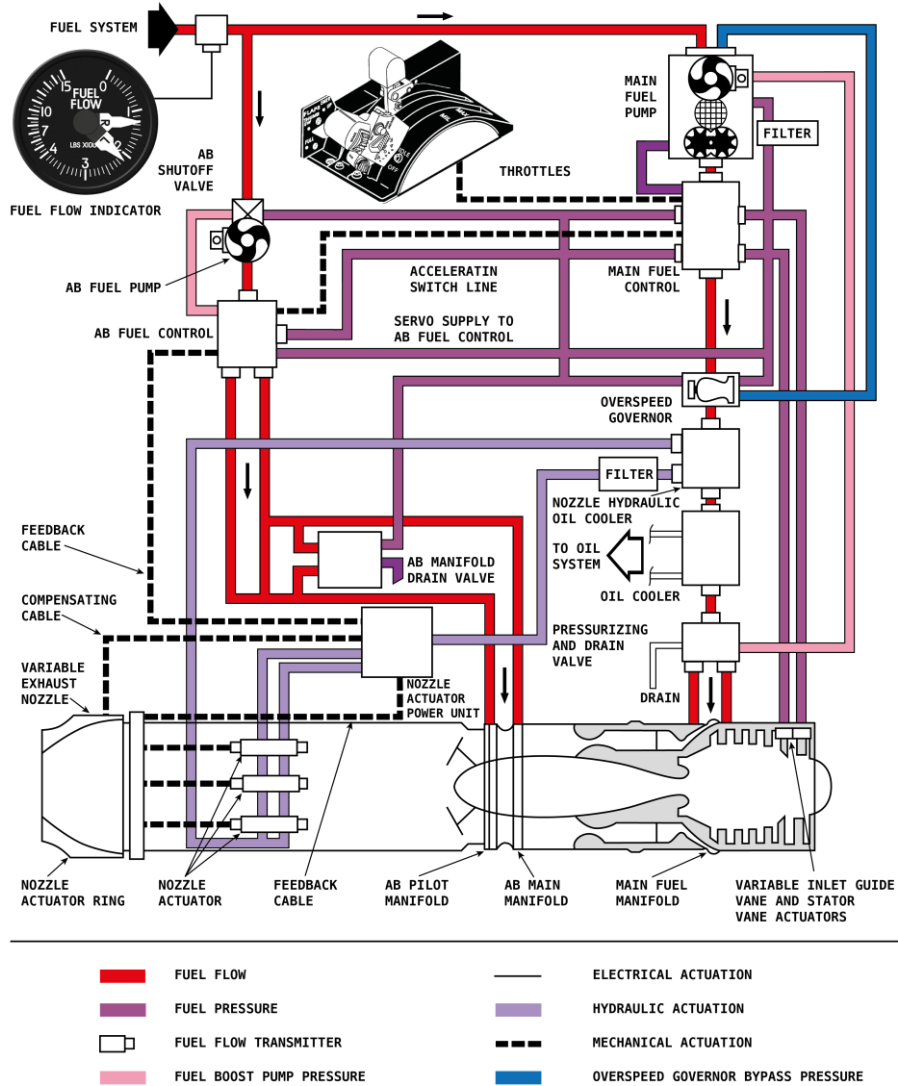

Fuel System

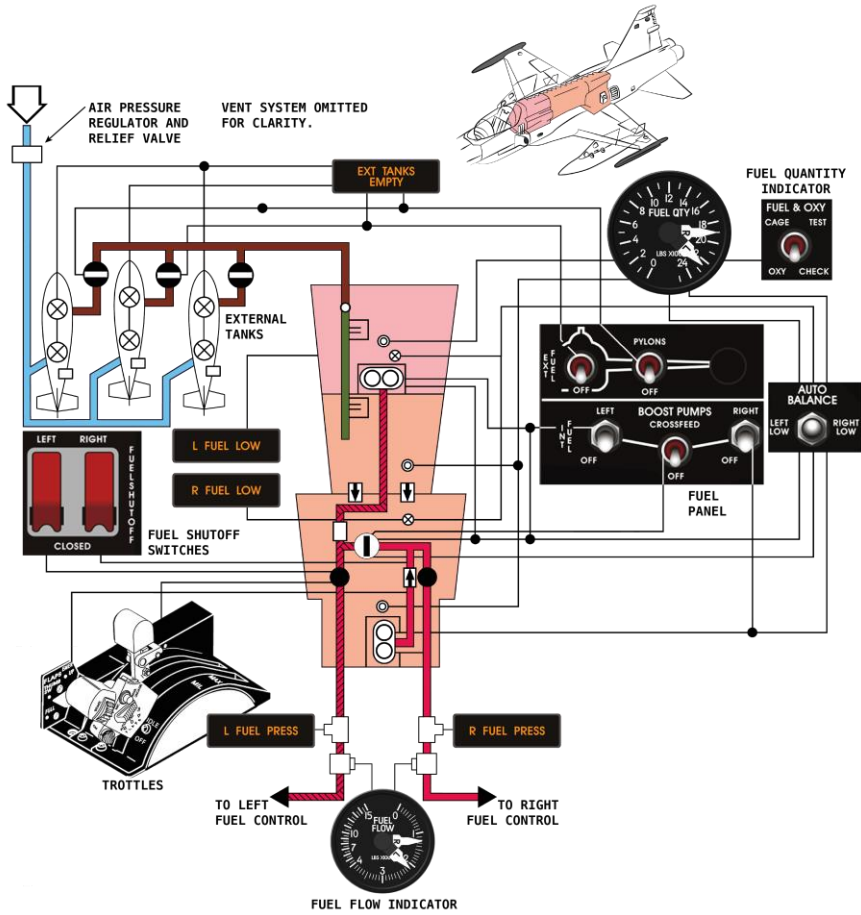

	LEFT FUEL SUPPLY		FUEL QUANTITY PROBE		CHECK VALVE
	RIGHT FUEL SUPPLY		ENGINE BLEED AIR		FUEL FLOW TRANSMITTER
	EXTERNAL FUEL SUPPLY		BOOST PUMP		CROSSFEED VALVE
	SINGL-POINT FUELING LINE		ELECTRICAL ACTUATION		LEFT SYSTEM
	SINGL-POINT MANIFOLD		FUEL SHUTOFF VALVE		RIGHT SYSTEM
	FUEL FLOAT SWITCH		FUEL CONTROL VALVE		FUEL PRESSURE SWITCH
	TANK PRESSURE RELIEF VALVE				

Electrical System

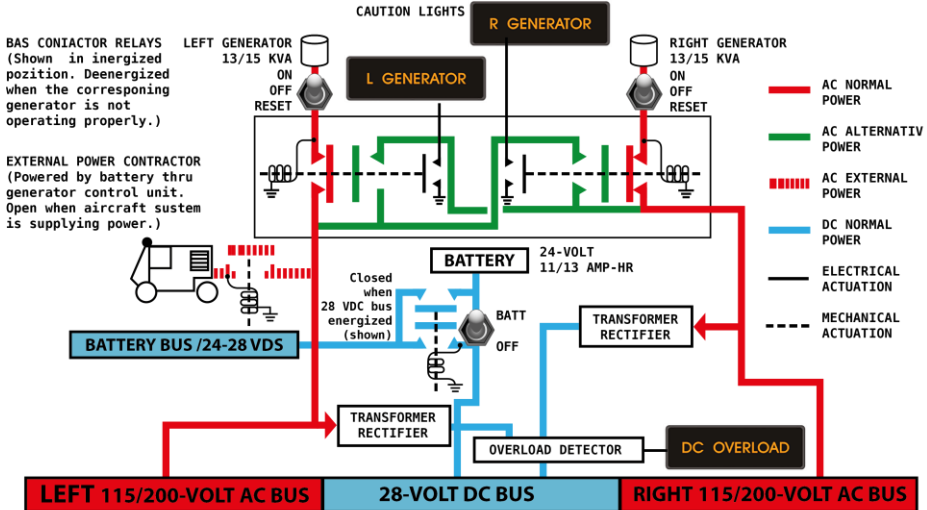

- LEFT 115/200-VOLT AC BUS**
- AHRS [DC]
 - AIM-9 POWER
 - AOA HEATER
 - ① AOA INDICATOR [DC]
 - ARMAMENT PANEL LIGHTS
 - CENTRAL AIR DATA COMPUTER [DC]
 - COCKPIT AIR-CONDITIONING
 - CONSOLE LIGHTS
 - ENGINE IGNITION
 - FLOOD LIGHTS (NORMAL)
 - FUEL QUANTITY, PRIMARY
 - GUN FIRING
 - IFF/SIF [DC]
 - LEADING EDGE FLAP MOTORS [DC]
 - ① L AUX INTAKE DOOR
 - L FUEL BOOST PUMP
 - L FUEL FLOW INDICATOR
 - ① L HYDRAULIC PRESSURE INDICATOR
 - ① L OIL PRESSURE INDICATOR
 - NOSE EQUIPMENT BAY COOLING
 - OPTICAL SIGHT [DC]
 - OPTICAL SIGHT LIGHTS (RETICLE)
 - ① PITCH TRIM INDICATOR
 - ② POSITION & FORMATION LIGHTS [DC]
 - RADAR [DC]
 - ③ RECON CAMERA COMPARTMENT
 - COOLING & DEFOG
 - STABILITY AUGMENTER
 - TACAN [DC]
 - TOTAL TEMPERATURE PROBE HEATER
 - TRIM CONTROL
 - UHF/ADF [DC]
 - ① NO. 2 UHF/ADF [DC]
 - VOR/ILS [DC]
 - ① POWERED BY 26-VOLT AC THRU TRANSFORMER
 - ② POWERED BY 6-VOLT AC THRU TRANSFORMER
 - ③ ENGINE START SEQUENCE ONLY NO POWER TRANSFER TO
 - ④ OPPOSITE GENERATOR
 - ⑤ W/RECON NOSE

- 28-VOLT DC BUS**
- AC GENERATOR CONTROLS
 - AHRS [AC]
 - AIM-9 CONTROL
 - AIR CROSSBLEED VALVE
 - AOA INDICATOR [AC]
 - ARMAMENT-ARMING MODE SELECT, POWER & RELEASE
 - ARRESTING HOOK
 - AUX IN TAKE DOOR INDICATOR
 - CAUTION, WARNING & INDICATOR LIGHTS (BAR)
 - CENTRAL AIR DATA COMPUTER [AC]
 - ENGINE ANTI-ICE
 - ENGINE START & IGNITION CONTROL
 - EXTERNAL FUEL CONTROL VALVES
 - FIRE DETECTORS
 - FLAP CONTROL (LEADING & TRAILING EDGE) [AC]
 - FLAP INDICATOR
 - FLOOD LIGHTS (EMERGENCY)
 - FUEL & OXYGEN SWITCH
 - FUEL AUTOBALANCE SWITCH
 - FUEL CROSSFEED VALVE
 - FUEL SHUTOFF VALVES
 - GUN BAY PURGING & DEFLECTOR DOORS IFF/SIF [AC]
 - INTERPHONE
 - LEADING GEAR /FLAP
 - AUDIBLE WARNING
 - LEADING GEAR CONTROL FND SAFETY
 - LEADING/TAXI LIGHTS CONTROL [AC]
 - NOSEWHEEL STEERING CONTROL
 - NOZZLE POSITION INDICATORS
 - OPTICAL SIGHT [AC]
 - POSITION LIGHT CONTROL [AC]
 - RADAR [AC]
 - ③ RECON CAMERA CONTROLS
 - ③ RECON CAMERA OPERATE LIGHTS
 - RWR [AC]
 - SIGHT CAMERA CONTROL
 - SPEED BRAKE CONTROLS
 - STANDBY ATTITUDE INDICATOR
 - TACAN AC
 - UHF RADIO
 - NO. 2 UHF RADIO
 - UHF/ADF [AC]
 - NO. 2 UHF/ADF [AC]
 - UTILITY LIGHT
 - VOR/ILS [AC]

- RIGHT 115/200-VOLT AC BUS**
- BLANCING ELECTRONIC UNIT
 - CABIN AIR VALVES
 - CANOPY SEAL
 - CAUTION, WARNING & INDICATOR LIGHTS (DIM)
 - ENGINE INSTRUMENT LIGHTS
 - FLIGHT INSTRUMENT LIGHTS
 - FUEK QUANTITY, SECONDARY
 - LANDING/TAXI LIGHTS [DC]
 - NOSE INSTRUMENT BAY COOLING
 - OXYGEN QUANTITY
 - PITOT HEATER
 - R AUX INTAKE DOOR
 - R EGT INDICATOR
 - R FUEL BOOST PUMP
 - R FUEL FLOW INDICATOR
 - ① R HYDRAULIC PRESSURE INDICATOR
 - ① R OIL PRESSURE INDICATOR
 - ROTATING BEACON
 - RWR [DC]
 - SEAT ADJUSTMENT
 - SIGHT CAMERA POWER
 - TRAILING EDGE FLAP MOTORS [DC]
- STATIC INVERTER 115-VOLT AC**
- FUEL & OXYGEN QUANTITY CHECK
 - ENGINE IGNITION (EITHER ENGINE) (NO GEN OR EXT PWA)
 - ③ LEFT ENGINE EGT, FUEL FLOW & OIL PRESSURE
 - ③ LEFT HYDRAULIC PRESSURE
- [AC] REQUIRES AC POWER
[DC] REQUIRES DC POWER

Hydraulic Systems

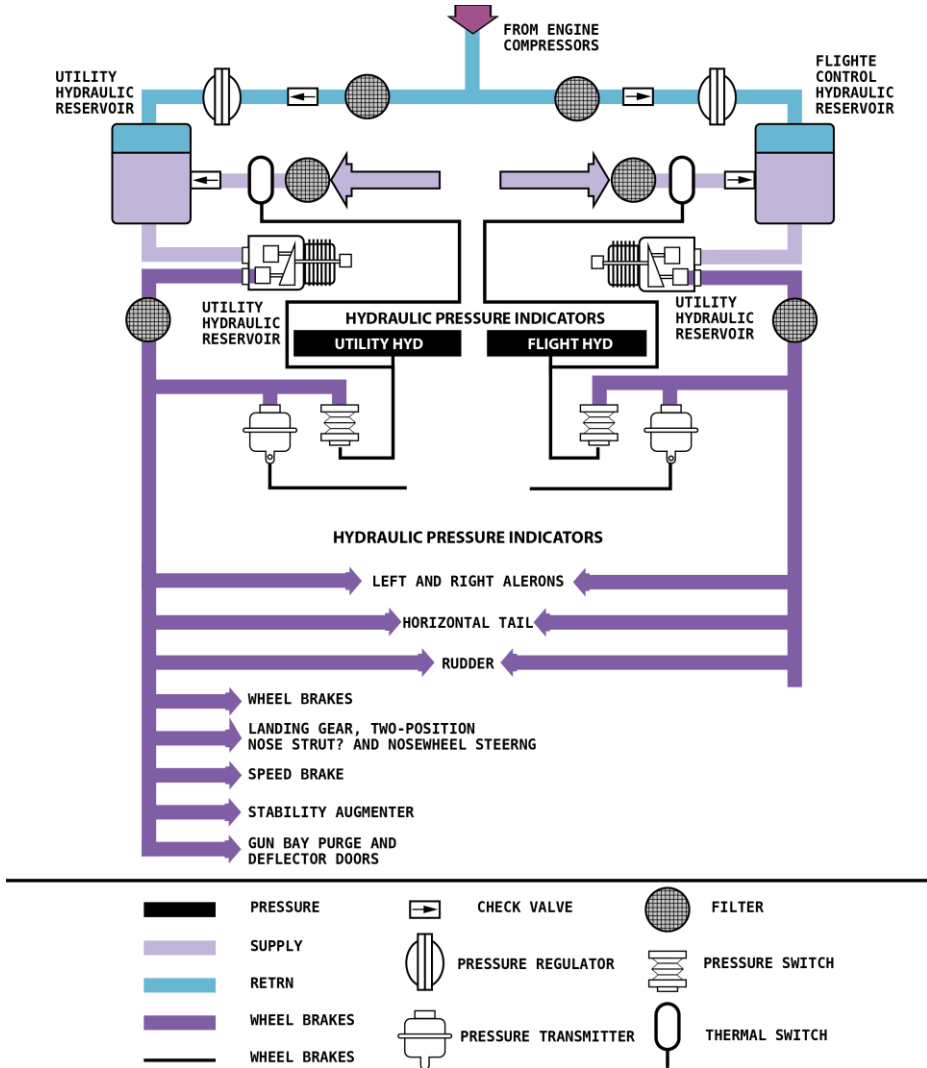

Environmental Control System

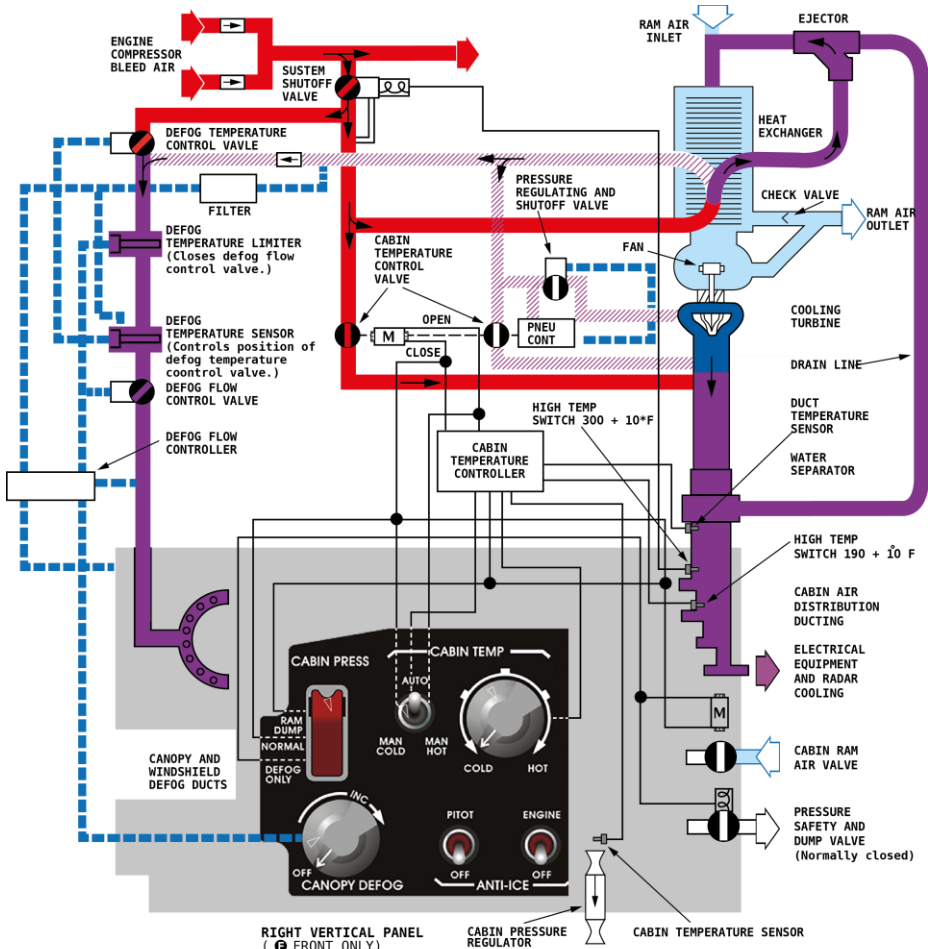

- | | | |
|-------------------------------|-------------------------------|--------------------------|
| HOT ENGINE-COMPRESSOR AIR | PNEUMATIC SENSING AND CONTROL | COLENOID VALVE |
| COOLING TURBINE COLD AIR | MECHANICAL ACTUATION | MOTOR OPERATED VALVE |
| RAM AIR | ELECTRICAL ACTUATION | PNEUMATIC OPERATED VALVE |
| COOLEST ENGINE-COMPRESSOR AIR | CHECK VALVE | ELECTRO PNEUMATIC VALVE |
| CONDITIONED AIR | PRESSURIZED AREA | |



14 KEY COMMANDS

14 KEY COMMANDS

General	
Multiplayer chat - mode All	Tab
Multiplayer chat - mode Allies	Tab + LCtrl
Chat read/write All	Tab + LShift
Chat show/hide	Y + LCtrl + LShift
End mission	Esc
Pause	Pause
Time accelerate	Z + LCtrl
Time decelerate	Z + LAlt
Time normal	Z + LShift
Score window	'
Info bar view toggle	Y + LCtrl
Get new plane - respawn	Tab + RCtrl + RShift
Jump into selected aircraft	J + RAlt
Screenshot	SysRQ
Frame rate counter - Service info	Pause + RCtrl
Info bar coordinate units toggle	Y + LAlt
Clickable mouse cockpit mode On/Off	C + LAlt
Sound On/Off	S + LCtrl
Rearming and Refueling Window	' + LAlt
View briefing on/off	B + LAlt
Show controls indicator	Enter + RCtrl
Show pilot body	P + RShift
Flight Control	
Aircraft Pitch Down	Up
Aircraft Pitch Up	Down
Aircraft Bank Left	Left
Aircraft Bank Right	Right
Aircraft Rudder Left	Z
Aircraft Rudder Right	X
Cheat	
Auto Start	Home + LWin
Auto Stop	End + LWin
Recorder On	R + LCtrl + LShift
Recorder Off	R + LAlt + LShift
Ground Adjustment	
Change LAU-3/-60 Firing Rate - Single/Ripple(17.2ms)/Ripple(60ms)	1 + RShift + RAlt
Change LAU-68 Firing Rate - Single/Ripple(60ms)	2 + RShift + RAlt
Change Chaff Burst Count - 1/2/3/4/6/8	3 + RShift + RAlt
Change Chaff Salvo Count - 1/2/4/8/C	4 + RShift + RAlt
Change Chaff Burst Interval (seconds) - 0.1/0.2/0.3/0.4	5 + RShift + RAlt

Change Chaff Salvo Interval (seconds) - 1/2/3/4/5/8/R	6 + RShift + RAlt
Change Flare Burst Count - 1/2/4/8/C	7 + RShift + RAlt
Change Flare Burst Interval (seconds) - 3/4/6/8/10	8 + RShift + RAlt
Instrument Panel	
Landing Gear Lever - LG UP/LG DOWN	G
Landing Gear Lever - LG UP	G + LCtrl
Landing Gear Lever - LG DOWN	G + LShift
Landing Gear Downlock Override Button	O
Landing Gear and Flap Warning Silence Button	I
Left Landing Gear Lamp - TEST	1 + LAlt
Nose Landing Gear Lamp - TEST	2 + LAlt
Right Landing Gear Lamp - TEST	3 + LAlt
Left Landing Gear Lamp Brightness - CCW/Decrease	A + RCtrl
Left Landing Gear Lamp Brightness - CW/Increase	Q + RCtrl
Nose Landing Gear Lamp Brightness - CCW/Decrease	S + RCtrl
Nose Landing Gear Lamp Brightness - CW/Increase	W + RCtrl
Right Landing Gear Lamp Brightness - CCW/Decrease	D + RCtrl
Right Landing Gear Lamp Brightness - CW/Increase	E + RCtrl
Arresting Hook Button	H
Drag Chute T-Handle - PULL/PUSH	P
Airspeed/Mach Indicator Index Setting Pointer Knob - CCW/Decrease	Q + LShift + LAlt
Airspeed/Mach Indicator Index Setting Pointer Knob - CW/Increase	W + LShift + LAlt
AI Pitch Trim Knob - CCW/Decrease	D + LShift + LAlt
AI Pitch Trim Knob - CW/Increase	E + LShift + LAlt
FAST ERECT Button	F + LShift + LAlt
Altimeter Zero Setting Knob - CCW/Decrease	A + LShift + LAlt
Altimeter Zero Setting Knob - CW/Increase	S + LShift + LAlt
Altimeter Mode Control Lever - ELECT(ric)	T + LShift + LAlt
Altimeter Mode Control Lever - PNEU(matic)	Y + LShift + LAlt
HSI Heading Set Knob - CCW/Decrease	1 + LShift + LAlt
HSI Heading Set Knob - CW/Increase	2 + LShift + LAlt
HSI Course Set Knob - CCW/Decrease	3 + LShift + LAlt
HSI Course Set Knob - CW/Increase	4 + LShift + LAlt
SAI Cage/Pitch Trim Knob - CCW/Decrease	X + LShift + LAlt
SAI Cage/Pitch Trim Knob - CW/Increase	V + LShift + LAlt
SAI Cage/Pitch Trim Knob - PULL	C + LShift + LAlt
Accelerometer Reset Button	A + RAlt
Clock Elapsed Time Knob - PUSH/RELEASE	T + RAlt
Clock Winding and Setting Knob - PULL/RELEASE	C + RAlt
Clock Winding and Setting Knob - CCW	K + RAlt
Clock Winding and Setting Knob - CW	L + RAlt
Master Caution Button	/ + RAlt
Instrument Panel, RWR	
RWR Indicator Control MODE Button	6 + RAlt
RWR Indicator Control SEARCH Button	7 + RAlt

RWR Indicator Control HANDOFF Button	8 + RAlt
RWR Indicator Control LAUNCH Button	9 + RAlt
RWR Indicator Control ALTITUDE Button	0 + RAlt
RWR Indicator Control T Button	Y + RAlt
RWR Indicator Control SYS TEST Button	U + RAlt
RWR Indicator Control UNKNOWN SHIP Button	I + RAlt
RWR Indicator Control ACT/PWR Button	O + RAlt
RWR Indicator Control POWER Button	P + RAlt
RWR Indicator Control AUDIO Knob - CCW/Decrease	- + RAlt
RWR Indicator Control AUDIO Knob - CW/Increase	= + RAlt
RWR Indicator Control DIM Knob - CCW/Decrease	[+ RAlt
RWR Indicator Control DIM Knob - CW/Increase] + RAlt
RWR Indicator INT Knob - CCW/Decrease	, + RAlt
RWR Indicator INT Knob - CW/Increase	. + RAlt
Left Panels	
Nose Strut Switch - EXTEND/RETRACT	Q + LCtrl + LAlt
Nose Strut Switch - EXTEND	
Nose Strut Switch - RETRACT	
Yaw Damper Switch - YAW/OFF	E + LCtrl + LAlt
Pitch Damper Switch - PITCH/OFF	W + LCtrl + LAlt
Rudder Trim Knob - CCW/Left	R + LCtrl + LAlt
Rudder Trim Knob - CW/Right	T + LCtrl + LAlt
Left Vertical Panel	
Landing & Taxi Light Switch - ON/OFF	Z + LCtrl + LShift
Left Engine Start Button	C + LCtrl + LShift
Right Engine Start Button	V + LCtrl + LShift
Left Fuel Shutoff Switch Cover - OPEN/CLOSE	N + LCtrl + LShift
Left Fuel Shutoff Switch - LEFT/CLOSED	H + LCtrl + LShift
Right Fuel Shutoff Switch Cover - OPEN/CLOSE	M + LCtrl + LShift
Right Fuel Shutoff Switch - RIGHT/CLOSED	J + LCtrl + LShift
Armament Panel Lights Knob - CCW/Decrease	, + LCtrl + LShift
Armament Panel Lights Knob - CW/Increase	. + LCtrl + LShift
Missile Volume Knob - CCW/Decrease	- + LCtrl + LShift
Missile Volume Knob - CW/Increase	= + LCtrl + LShift
Interval Switch [sec] - Up	Q + LCtrl + LShift
Interval Switch [sec] - Down	A + LCtrl + LShift
Armament Position Selector Switch (LEFT WINGTIP) - ON/OFF	1 + LCtrl + LShift
Armament Position Selector Switch (LEFT OUTBD) - ON/OFF	2 + LCtrl + LShift
Armament Position Selector Switch (LEFT INBD) - ON/OFF	3 + LCtrl + LShift
Armament Position Selector Switch (CENTERLINE) - ON/OFF	4 + LCtrl + LShift
Armament Position Selector Switch (RIGHT INBD) - ON/OFF	5 + LCtrl + LShift
Armament Position Selector Switch (RIGHT OUTBD) - ON/OFF	6 + LCtrl + LShift
Armament Position Selector Switch (RIGHT WINGTIP) - ON/OFF	7 + LCtrl + LShift
Bombs Arm Switch - CW	E + LCtrl + LShift



Bombs Arm Switch - CCW	W + LCtrl + LShift
Guns, Missile and Camera Switch Cover - OPEN/CLOSE	T + LCtrl + LShift
Guns, Missile and Camera Switch - Up	G + LCtrl + LShift
Guns, Missile and Camera Switch - Down	B + LCtrl + LShift
External Stores Selector - CW] + LCtrl + LShift
External Stores Selector - CCW	[+ LCtrl + LShift
Emergency All Jettison Button Cover - OPEN	9 + LCtrl + LShift
Emergency All Jettison Button	0 + LCtrl + LShift
Select Jettison Button	D + LCtrl + LShift
Select Jettison Switch - Up	S + LCtrl + LShift
Select Jettison Switch - Down	F + LCtrl + LShift
Landing Gear Alternate Release Handle - PULL/STOW	8 + LCtrl + LShift
Pedestal Panels	
Nav Mode Selector Switch - DF/TACAN	N + LAlt
Rudder Pedal Adjust T-Handle - PULL/STOW	P + LCtrl + LShift + LAlt
Right Panels, Lighting Control Panel	
Warning Lights Test Switch - TEST/OFF	/ + RCtrl + RAlt
Warning Lights Brightness Switch - BRT/OFF	E + RCtrl + RAlt
Warning Lights Brightness Switch - DIM/OFF	D + RCtrl + RAlt
Exterior Lights Nav Knob - CCW/Decrease	K + RCtrl + RAlt
Exterior Lights Nav Knob - CW/Increase	I + RCtrl + RAlt
Exterior Lights Formation Knob - CCW/Decrease	L + RCtrl + RAlt
Exterior Lights Formation Knob - CW/Increase	O + RCtrl + RAlt
Exterior Lights Beacon Switch - ON/OFF	P + RCtrl + RAlt
Flood Lights Knob - CCW/Decrease	F + RCtrl + RAlt
Flood Lights Knob - CW/Increase	R + RCtrl + RAlt
Flight Instruments Lights Knob - CCW/Decrease	G + RCtrl + RAlt
Flight Instruments Lights Knob - CW/Increase	T + RCtrl + RAlt
Engine Instruments Lights Knob - CCW/Decrease	H + RCtrl + RAlt
Engine Instruments Lights Knob - CW/Increase	Y + RCtrl + RAlt
Console Lights Knob - CCW/Decrease	J + RCtrl + RAlt
Console Lights Knob - CW/Increase	U + RCtrl + RAlt
Right Panels, Oxygen Control Panel	
Oxygen Supply Lever - ON/OFF	P + RCtrl
Oxygen Diluter Lever - Down/Decrease	L + RCtrl
Oxygen Diluter Lever - Up/Increase	O + RCtrl
Oxygen Emergency Lever - Up	U + RCtrl
Oxygen Emergency Lever - Down	J + RCtrl
Right Vertical Panel	
Battery Switch - BATT/OFF	B + RCtrl + RShift
Left Generator Switch - Up	H + RCtrl + RShift
Left Generator Switch - Down	N + RCtrl + RShift
Right Generator Switch - Up	J + RCtrl + RShift
Right Generator Switch - Down	M + RCtrl + RShift
Canopy Jettison T-Handle - PULL/PUSH	K + RCtrl + RShift
Ext Fuel CI Switch - ON/OFF	R + RCtrl + RShift



Ext Fuel Pylons Switch - ON/OFF	T + RCtrl + RShift
Left Boost Pump Switch - ON/OFF	Y + RCtrl + RShift
Crossfeed Switch - OPEN/CLOSED	U + RCtrl + RShift
Right Boost Pump Switch - ON/OFF	I + RCtrl + RShift
Autobalance Switch - LEFT/NEUT	[+ RCtrl + RShift
Autobalance Switch - RIGHT/NEUT] + RCtrl + RShift
Pitot Anti-Ice Switch - PITOT/OFF	F + RCtrl + RShift
Engine Anti-Ice Switch - ENGINE/OFF	G + RCtrl + RShift
Cabin Temperature Switch - CW	E + RCtrl + RShift
Cabin Temperature Switch - CCW	W + RCtrl + RShift
Cabin Temperature Knob - CCW/Decrease	S + RCtrl + RShift
Cabin Temperature Knob - CW/Increase	D + RCtrl + RShift
Canopy Defog Knob - CCW/Decrease	X + RCtrl + RShift
Canopy Defog Knob - CW/Increase	C + RCtrl + RShift
Cabin Pressure Switch Cover - OPEN/CLOSE	Q + RCtrl + RShift
Cabin Pressure Switch - Up	A + RCtrl + RShift
Cabin Pressure Switch - Down	Z + RCtrl + RShift
Cockpit Air Inlet - Left	, + RCtrl + RShift
Cockpit Air Inlet - Right	/ + RCtrl + RShift
Cockpit Air Inlet - Down	. + RCtrl + RShift
Cockpit Air Inlet - Up	; + RCtrl + RShift
Fuel & Oxygen Switch - GAGE TEST/OFF	O + RCtrl + RShift
Fuel & Oxygen Switch - QTY CHECK/OFF	L + RCtrl + RShift
Compass Switch - Up	Y + RCtrl
Compass Switch - Down	H + RCtrl
Stick	
Pitch Damper Cutoff Switch	A
Nosewheel Steering Button	S
Weapon Release Button	Space + RAlt
Gun Trigger - FIRST DETENT	T
Gun Trigger - SECOND DETENT (Press to shoot)	Space
Dogfight/Resume Search Switch - FORWARD (DM)	5
Dogfight/Resume Search Switch - CENTER-PRESS (RESUME SEARCH)	R
Dogfight/Resume Search Switch - AFT (DG)	6
Stick, Flight Control	
Aileron Limiter (Hold to turn off)	L
Elevator Trimmer Switch - PUSH(DESCEND)	; + RCtrl
Elevator Trimmer Switch - PULL(CLIMB)	. + RCtrl
Aileron Trimmer Switch - LEFT WING DOWN	, + RCtrl
Aileron Trimmer Switch - RIGHT WING DOWN	/ + RCtrl
Systems	
Wheel Brake - ON/OFF	W
Wheel Brake Left - ON/OFF	W + LCtrl
Wheel Brake Right - ON/OFF	W + LAlt
Canopy - OPEN/CLOSE	C + LCtrl

Eject (3 times)	E + LCtrl
Throttle Quadrant	
Throttle (Left) - IDLE	Home + RAlt
Throttle (Left) - OFF	End + RAlt
Throttle (Right) - IDLE	Home + RShift
Throttle (Right) - OFF	End + RShift
Speed Brake Switch - Cycle	B
Speed Brake Switch - OUT	B + LShift
Speed Brake Switch - IN	B + LCtrl
Flap Lever - EMER UP	D + LShift
Flap Lever - THUMB SW	D
Flap Lever - FULL	D + LCtrl
Flap Switch - UP	F + LShift
Flap Switch - FIXED	F + LCtrl
Flap Switch - AUTO	F
Flare-Chaff Button	Q
Missile Uncage Switch	M + RShift
Throttle Quadrant, AN/ASG-31 Sight	
AN/ASG-31 Sight Cage Switch	C + LShift
Throttle Quadrant, Flight Control	
Throttle Smoothly (Both) - Increase	Num+
Throttle Smoothly (Both) - Decrease	Num-
Throttle Smoothly (Left) - Increase	Num+ + RAlt
Throttle Smoothly (Left) - Decrease	Num- + RAlt
Throttle Smoothly (Right) - Increase	Num+ + RShift
Throttle Smoothly (Right) - Decrease	Num- + RShift
Throttle Step (Both) - Increase	PageUp
Throttle Step (Both) - Decrease	PageDown
Throttle Step (Left) - Increase	PageUp + RAlt
Throttle Step (Left) - Decrease	PageDown + RAlt
Throttle Step (Right) - Increase	PageUp + RShift
Throttle Step (Right) - Decrease	PageDown + RShift
UHF Radio ARC-164 Control Panel, Pedestal Panels	
UHF Radio Preset Chanel Selector - Decrease	P + LCtrl
UHF Radio Preset Chanel Selector - Increase	P + LShift
UHF Radio 100Mhz Selector Switch - CW/Increase	1 + LShift
UHF Radio 100Mhz Selector Switch - CCW/Decrease	1 + LCtrl
UHF Radio 10Mhz Selector - Decrease	2 + LCtrl
UHF Radio 10Mhz Selector - Increase	2 + LShift
UHF Radio 1Mhz Selector - Decrease	3 + LCtrl
UHF Radio 1Mhz Selector - Increase	3 + LShift
UHF Radio 0.1Mhz Selector - Decrease	4 + LCtrl
UHF Radio 0.1Mhz Selector - Increase	4 + LShift
UHF Radio 0.025Mhz Selector - Decrease	5 + LCtrl
UHF Radio 0.025Mhz Selector - Increase	5 + LShift
UHF Radio Volume Knob - CCW/Decrease	V + LCtrl

UHF Radio Volume Knob - CW/Increase	V + LShift
UHF Radio Function Selector Switch - CW	6 + LShift
UHF Radio Function Selector Switch - CCW	6 + LCtrl
UHF Radio Frequency Mode Selector Switch - CW	7 + LShift
UHF Radio Frequency Mode Selector Switch - CCW	7 + LCtrl
UHF Radio T-Tone Button	T + LShift
UHF Radio Squelch Switch - ON/OFF	S + LShift
UHF Radio Antenna Selector Switch - Up	A + LShift
UHF Radio Antenna Selector Switch - Down	A + LCtrl
UHF Radio ARC-164 Control Panel, Throttle Quadrant	
UHF Radio Microphone Button	\ + RAlt
AN/APQ-159 Radar Control Panel	
AN/APQ-159 Radar Scale Knob - CW/Increase	U + RShift
AN/APQ-159 Radar Scale Knob - CCW/Decrease	Y + RShift
AN/APQ-159 Radar Bright Knob - CW/Increase	J + RShift
AN/APQ-159 Radar Bright Knob - CCW/Decrease	H + RShift
AN/APQ-159 Radar Persistence Knob - CW/Increase	N + RShift
AN/APQ-159 Radar Persistence Knob - CCW/Decrease	B + RShift
AN/APQ-159 Radar Video Knob - CW/Increase	V + RShift
AN/APQ-159 Radar Video Knob - CCW/Decrease	C + RShift
AN/APQ-159 Radar Cursor Knob - CW/Increase	F + RShift
AN/APQ-159 Radar Cursor Knob - CCW/Decrease	D + RShift
AN/APQ-159 Radar Pitch Knob - CW/Up	T + RShift
AN/APQ-159 Radar Pitch Knob - CCW/Down	R + RShift
AN/APQ-159 Radar Elevation Antenna Tilt Control - CW/Up] + RShift
AN/APQ-159 Radar Elevation Antenna Tilt Control - CCW/Down	[+ RShift
AN/APQ-159 Radar TDC Button - Up	;
AN/APQ-159 Radar TDC Button - Down	.
AN/APQ-159 Radar TDC Button - Left	,
AN/APQ-159 Radar TDC Button - Right	/
AN/APQ-159 Radar Range Selector - CW/Increase	=
AN/APQ-159 Radar Range Selector - CCW/Decrease	-
AN/APQ-159 Radar Mode Selector - CW	0
AN/APQ-159 Radar Mode Selector - CCW	9
AN/APQ-159 Radar ACQ Button	Enter
AN/ASG-31 Sight	
AN/ASG-31 Sight Mode Selector - OFF	`
AN/ASG-31 Sight Mode Selector - MSL	1
AN/ASG-31 Sight Mode Selector - A/A1 GUNS	2
AN/ASG-31 Sight Mode Selector - A/A2 GUNS	3
AN/ASG-31 Sight Mode Selector - MAN	4
AN/ASG-31 Sight Reticle Intensity Knob - CCW/Decrease	- + RCtrl
AN/ASG-31 Sight Reticle Intensity Knob - CW/Increase	= + RCtrl
AN/ASG-31 Sight Reticle Depression Knob - CCW/Decrease	[+ RCtrl
AN/ASG-31 Sight Reticle Depression Knob - CW/Increase] + RCtrl

AN/ASG-31 Sight Panel Light Button - ON/OFF	I + RCtrl
AN/ASG-31 Sight BIT Switch - Up	T + RCtrl
AN/ASG-31 Sight BIT Switch - Down	G + RCtrl
AN/ASG-31 Sight, Sight Camera	
Sight Camera FPS Select Switch - 24/48	; + RShift + RAlt
Sight Camera Lens f-Stop Selector - CCW/Decrease	, + RShift + RAlt
Sight Camera Lens f-Stop Selector - CW/Increase	. + RShift + RAlt
Sight Camera Overrun Selector - Right/Decrease] + RShift + RAlt
Sight Camera Overrun Selector - Left/Increase	[+ RShift + RAlt
Sight Camera Run (Test) Switch	/ + RShift + RAlt
ARN-118 TACAN Control Panel, Pedestal Panels	
TACAN Mode Selector Switch - CW	Q + LShift
TACAN Mode Selector Switch - CCW	Q + LCtrl
TACAN Volume - Decrease	N + LCtrl
TACAN Volume - Increase	N + LShift
TACAN Channel Ones - Decrease	8 + LCtrl
TACAN Channel Ones - Increase	8 + LShift
TACAN Channel Tens - Decrease	9 + LCtrl
TACAN Channel Tens - Increase	9 + LShift
TACAN Mode X/Y Switch	Y + LShift
TACAN Test Button	T + LCtrl

F-5E Aerodynamic Drag Data

Zero-Lift Drag = $f(\text{Flight Cond.})$

Induced = $f(\text{Flight Cond.}, C_L)$

Wave Drag

Basic Drag

- Fuselage
- Wing
- H. Tail
- V. Tail
- ...

- Fuselage
- Wing
- H. Tail
- V. Tail
- ...

- Level Flight, Takeoff Wt.
- ...
- Level Flight, Combat Wt.
- ...
- Level Flight, Zero

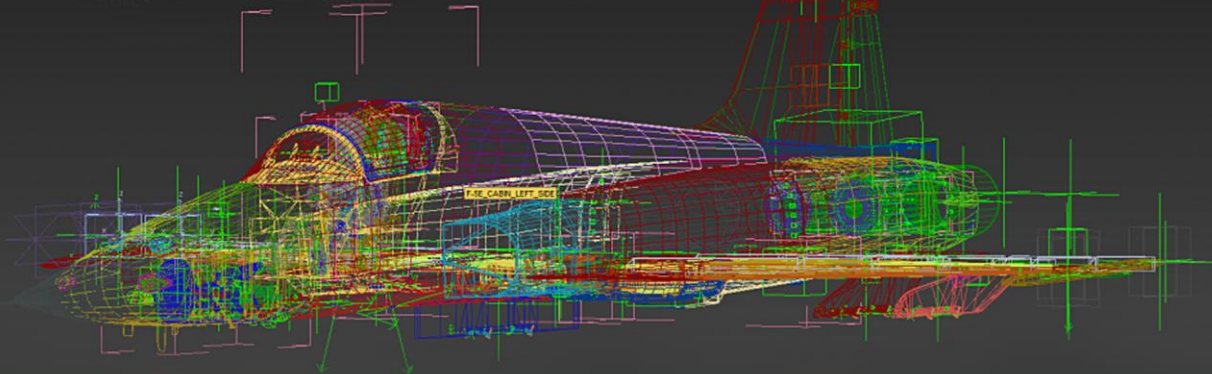

15 DEVELOPERS

15 DEVELOPERS

Management

Alexander "PilotMi8" Podvoyskiy
Александр "Foxhound_vva"

General manager
Project manager, games and technical documentation, alpha testing.

Alexander Pidchenko

Weapons systems and combat employment manager, alpha testing.

Programmers

Vladimir "cofcorpse" Timoshenko
Alexander "Alan Parker"
Nikolay Volodin
Alexey "Alex Wolf"
Alexander Mishkovich

Lead programmer
Flight dynamics
Flight dynamics
Engine, engine systems
Systems of aircraft, avionics, effects, damage model

Nikolay T
Konstantin "btd" Kuznetsov

Aircraft performance coordination
Sound developer, music composer

Designers

Pavel "DGambo" Sidorov
Vladislav "STAVR" Kuprin
Uriy Starov
Alexander "Skylark" Drannikov
Igor Piskunov

Lead designer
Cockpit designer
Aircraft designer
GUI graphic
2D designer

Video

Aleksey "x-stounds" Fedorov

Production of videos

Training

Vyacheslav "SL PAK" Paketny

Training missions

Quality Assurance

Valery "USSR_Rik" Khomenok
Ivan "Frogfoot" Makarov
Alexander "BillyCrusher" Bilievskiy

Lead-tester
Testing
Testing

Science Support

Sergey "Vladimirovich"

Modeling methodology

Localization

Alexey "Mode" Chistyakov
 Vitaliy "Zulu" Marchuk
 Julia "Umka" Marchuk

Localization Manager
 English translation
 English translation

Special Thanks

Vitaly "LazySeal" Kachan
 Eugeniya Kachan
 Ben Gavares

Editing the English version of the manual
 Editing the English version of the manual
 Editing the English version of the manual.

Tester Staff

Anthony "Blaze" Echavarria
 Christopher "Mustang" Wood
 Daniel "EtherealN" Agorander
 Danny "Stuka" Vanvelthoven
 Darrell "AlphaOneSix" Swoap
 Dmitry "Laivynas" Koshelev
 Dmitry "Simfreak" Stupnikov
 Edin "Kuky" Kulelija
 Erich "ViperVJG73" Schwarz
 Evan "Headspace" Hanau
 Gareth "Maverick" Moore
 Gavin "159th_Viper" Torr
 George "GGTharos" Lianeris
 Jeff "Grimes" Szorc
 John "Speed" Tatarchuk
 Jurgen "lion737" Dorn
 Kairat "Kairat" Jaksbaev

Matt "mdosio" Dosio
 Matthias "Groove" Techmanski
 Norm "SiThSpAwN" Loewen
 Peter "Weta43" McAllister
 Phil "Druid_" Phillips
 Philippe "Phil06" Affergan
 Raul "Furia" Ortiz de Urbina
 Roberto "Vibora" Seoane Penas
 Scott "BIGNEWY" Newnham
 Sergey "eekz" Gorecky
 Steve "joyride" Tuttle
 Vadim "Wadim" Ishuk
 Valery "=FV=BlackDragon" Manacian
 Victor "vic702" Kravchuk
 Werner "derelor" Siedenburg
 William "SkateZilla" Belmont
 Zachary "Luckybob9" Sesar